



# INSTALLATION & OPERATION MANUAL

## Wireless Tire Pressure and Temperature Monitoring System

### TST-770 Series Touch Screen Color Display

NOTE: 770 Display is compatible with all TST components with product date code 4519 and after.



#### ⚠ CAUTION

#### IMPORTANT REMINDER FOR YOUR TPMS DISPLAY

Temperatures inside of parked or stored vehicles can reach extreme levels. We want to remind you that the TST Display is powered by a lithium-ion (LI) battery and due to the nature of all LI batteries, they must not be exposed to extreme temperatures. When not in use, we recommend removing the displays from high heat areas, including, but not limited to dashboards, windshields, and direct sunlight, and to store them in cooler areas. Other common devices such as cell phone, Bluetooth headphones and laptops may utilize LI batteries and should be handled accordingly. Failure to do so may result in heat-related damage to the display, surrounding areas and/or injuries.



#### ⚠ WARNING

- **INGESTION HAZARD:** This product contains button cell or coin battery.
- **DEATH** or serious injury can occur if ingested.
- A swallowed button cell or coin battery can cause **Internal Chemical Burns** in as little as **2 hours**.
- **KEEP** new and used batteries **OUT OF REACH** of CHILDREN.
- **Seek immediate medical attention** if a battery is suspected to be swallowed or inserted inside any part of the body.



**BATTERY CAUTION:** Remove and immediately recycle or dispose of used batteries according to local regulations and keep away from children. Do NOT dispose of batteries in household trash or incinerate. Even used batteries may cause severe injury or death.

Call a local poison control center for treatment information.

Non-rechargeable batteries are not to be recharged.

Do not force discharge, recharge, disassemble, heat above (manufacturer's specified temperature rating) or incinerate. Doing so may result in injury due to venting, leakage or explosion resulting in chemical burns.

# TPMS QUICK INSTALLATION INSTRUCTIONS

These **QUICK INSTALLATION INSTRUCTIONS** will get you up and running. Please refer to the index in this manual for complete and detailed instructions and specifications for your TPMS product.

Remove screen protector and Power ON the display using switch on the right side of display. **SET THE FOLLOWING BEFORE PAIRING SENSORS:**

## COLD TIRE PRESSURE ALERT SETTINGS - TRAILER EXAMPLE

The following instructions will utilize the **Default** High/Low Pressure Alert thresholds. When inputting **Cold Tire Pressure (CTP)** with this option, **High Pressure Alert** will be set at 25% above CTP and **Low Pressure Alert** will automatically be set at 10% below CTP (for **Manual** High/Low Pressure Alert thresholds, go to page 13 of the manual).

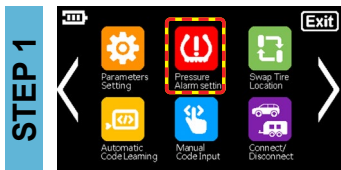

To adjust default **Cold Tire Pressure** settings, touch  to enter into **Pressure Alert Settings**.

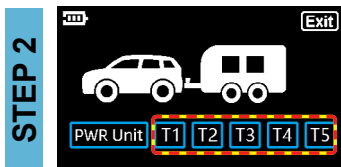

Touch **T1** to enter Trailer Cold Pressure screen for Trailer One. T2-T5 can be used for additional trailers.

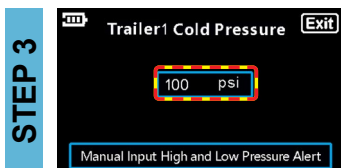

To set **Trailer Axle** cold tire pressure, touch  to enter the **Keyboard Input Screen**. Find the CTP value on the manufacturers placard, usually on the front drivers side of the trailer.

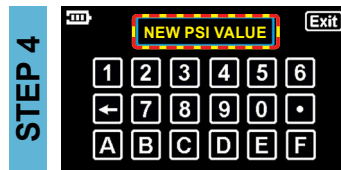

Enter your preferred Cold Tire Pressure.



Touch  to exit **Keyboard Input Screen** after **Trailer Axle** cold tire pressure settings are changed. **Trailer (1, 2, 3, 4 or 5) Axle Cold Pressure** screen will appear.

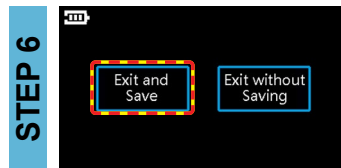

Touch  again to exit **Trailer Axle Cold Pressure** screen. To save your input, touch **Exit and Save**. To cancel, touch **Exit without Saving**. Selection returns you to the Power Unit/Trailer **Main Screen**.

**NOTE: 770 Display is compatible with all TST components with product date code 4519 and after.**

# TPMS QUICK INSTALLATION INSTRUCTIONS

These QUICK INSTALLATION INSTRUCTIONS will get you up and running. Please refer to the index in this manual for complete and detailed instructions and specifications for your TPMS product.

PAIR SENSORS AFTER SETTING COLD TIRE PRESSURE ALERT SETTINGS ON PAGE 2:

## AUTOMATIC CODE LEARNING - TRAILER EXAMPLE



Touch **Automatic Code Learning** to enter into **Automatic Code Learning** settings.

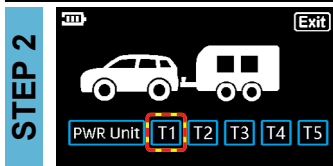

Touch **T1**, **T2**, **T3**, **T4** or **T5** to enter **Sensor Code Learning** settings for respective trailer.

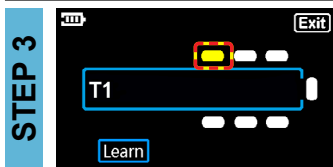

Touch **T1** to select the tire you want to code to the sensor. Selected tire will flash white and yellow and the **Learn** icon will appear on the screen.

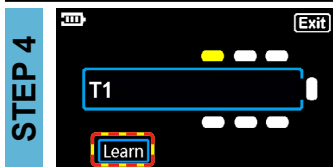

Touch **Learn** icon. Icon will change to **Learn**. Touch a sensor to the **Sensor Pairing Area** on back of the display (see images at right) to learn sensor ID code.

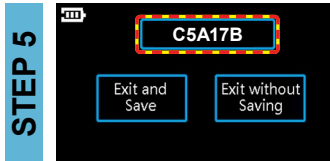

If sensor code learning is successful, sensor ID code (Example: C5A17B) will appear on **Sensor Code Capture** screen with options to **Exit and Save**. After successful code learning, touch **Exit and Save** to return to sensor code learning screen.

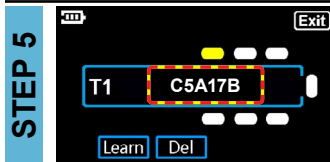

The programmed tire position will blink yellow and sensor code will show (Example: C5A17B) in power unit on **Sensor Code Learning** screen.

Repeat for remaining tire positions.

Touch **Exit** to finish and return to **Main Screen**. Learned code tire positions will blink yellow and will show pressure and temperature readings.

**NOTE:** For internal sensors hold the **Sensor Pairing Area** to the tire, at the sensor location, which is located 180° from the valve stem.

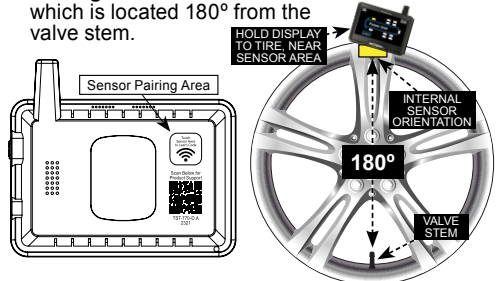

## TABLE OF CONTENTS

SENSOR FEATURES.....	5
DISPLAY FEATURES.....	5
TST-770 SYSTEM COMPONENTS - DISPLAY.....	6
SYSTEM COMPATIBLE COMPONENTS*.....	6
DISPLAY CONTROLS AND INFORMATION.....	7
DISPLAY INSTALLATION AND CHARGING.....	7
TST-770 SYSTEM DEFAULT SETTINGS.....	8
COLD TIRE PRESSURE (CTP) SYSTEM DEFAULT SETTINGS.....	8
MAIN SCREEN.....	9
UNDERSTANDING YOUR TIRE ALERTS.....	10
UNDERSTANDING YOUR TIRE ALERTS (CONT.).....	11
OTHER FUNCTIONS.....	11
PARAMETER SETTINGS.....	12
COLD TIRE PRESSURE ALERT SETTINGS - POWER UNIT.....	13
COLD TIRE PRESSURE ALERT SETTINGS - TRAILERS.....	14
MANUAL HIGH/LOW PRESSURE ALERT SETTINGS.....	15
SWAP TIRE LOCATION.....	16
AUTOMATIC CODE LEARNING.....	17
AUTOMATIC CODE LEARNING (CONT.).....	18
CONNECT/DISCONNECT.....	19
CUSTOM VEHICLE ID.....	20
CUSTOM VEHICLE ID (CONT.).....	21
DATE & TIME SETTINGS.....	22
SENSOR BATTERY VOLTAGE.....	23
RESET.....	24
ABOUT.....	25
SENSOR INSTALLATION - CAP SENSOR.....	26
SENSOR INSTALLATION - FLOW-THRU SENSOR.....	27
SENSOR PREPARATION - INTERNAL SENSORS.....	28
SENSOR INSTALLATION TO WHEEL - INTERNAL SENSORS.....	29
DUAL WHEEL INSTALLATION - INTERNAL SENSORS.....	30
REPLACING THE FLOW-THRU SENSOR BATTERY (CR1632).....	31
REPLACING THE FLOW-THRU SENSOR BATTERY (CR2032).....	32
REPLACING THE CAP SENSOR BATTERY (CR2032).....	33
REPEATER.....	34
TROUBLESHOOTING TIPS.....	35-37
SENSOR SPECIFICATIONS.....	38
DISPLAY SPECIFICATIONS.....	38
PROGRAMMED SENSOR REFERENCE DIAGRAM.....	39

## SENSOR FEATURES

1. The sensors easily install on the valve stem, can be installed inside the wheel/tire assembly or came from the factory installed inside the wheel/tire assembly.
2. Most sensors are water resistant, while hybrid sensors are approved for water immersion.
3. Removal of a screw on sensor will shut off the sensor battery.
4. Cap and flow-thru sensor batteries last approximately 1-1.5 years and have a user replaceable battery. Internal sensor batteries last approximately four (4) years depending on use and environmental conditions.
5. Tire leaks and high temperatures are detected quickly.
6. With flow-thru sensors, tires can be inflated without removing the sensor.
7. Each sensor has a unique, six (6) digit alpha numeric code for programming.

## DISPLAY FEATURES

1. NEW: 5-inch LCD color touch screen display for ease of programming.
2. NEW: Magnetic dock on the display back for included suction cup mount, or any magnetic mount of your choosing.
3. NEW: Enter your cold tire pressure to automatically set high and low alert thresholds. High alert threshold defaults to 25% above cold tire pressure and low alert threshold defaults to 10% below cold tire pressure. These thresholds are also user adjustable.
4. NEW: sensor battery voltage status feature.
5. NEW: USB-C power cord and adapter.
6. Compatible with TST-507 components with product date code 4519 and after.
7. Rechargeable internal lithium battery.
8. Automatic display brightness, depending on lighting conditions.
9. Visual, audible and textual warning alerts will let you know when pressure, temperature or battery voltage are outside of automatic or user programmed threshold.
10. Tire pressure can be displayed in PSI or BAR.
11. Temperature can be displayed in °C or °F.
12. Will monitor power unit and up to five (5) trailers and a total of 46 tire positions including spares.
13. Scrolling tire pressure and temperature readings are displayed simultaneously for quick viewing of each tire - or if you need to check a specific tire our NEW touch screen allows you to tap any tire position for instant temperature and pressure info.
14. Built in GPS displays direction of travel, time, date, speed, trip distance and altitude (this is not a navigation tool). Please allow up to 15 minutes for the GPS to initialize the first time. **Note: GPS feature may not be available on certain models.**

## TST-770 SYSTEM COMPONENTS - DISPLAY

### Display and Components

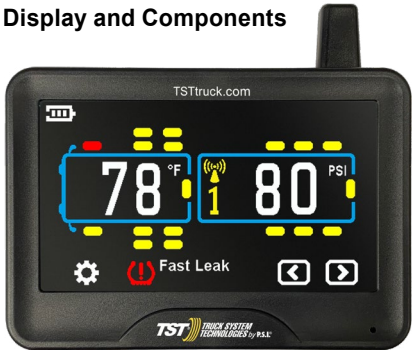

5" Touch Screen Color Display  
(Contains non-replaceable Lithium-ion battery 3.7V)



Magnetic Display Mount

12v Power Adapter

USB-C Cable

Suction Cup Mount

## SYSTEM COMPATIBLE COMPONENTS\*

\* Beginning with product date code 4519 and after.

### TST Internal Sensors



Screw-mounted Internal Sensors & Band  
(Contains non-replaceable battery CR2450 3V)



Slide-on Internal Sensors & Band  
(Contains non-replaceable battery CR2450 3V)



Slide-on Internal Sensors with Antenna & Band  
(Contains non-replaceable battery CR2450 3V)

### TST RV Cap Sensor



(Contains replaceable battery CR2032 3V)

### TST Hybrid Cap Sensor



(Contains non-replaceable battery CR2450 3V)

### TST Flow-thru Sensors



(Contains replaceable battery CR2032 3V)



(Contains replaceable battery CR1632 3V)

**Note:** Hybrid/Marine and Flow-thru Sensors require metal valve stems.

### TST Repeaters







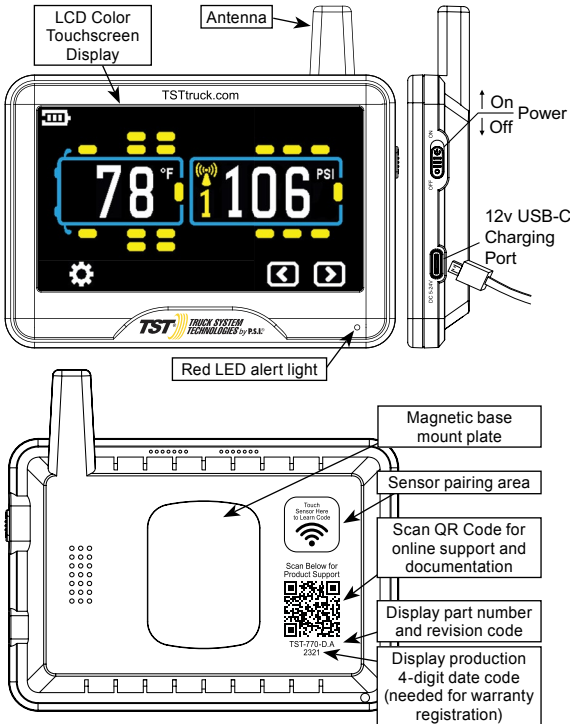



The repeater is an integral component to your TPMS system. Failure to install the repeater could void the warranty coverage.



## DISPLAY CONTROLS AND INFORMATION









### Display ICONS

	Tire Icon (not yet coded)
	Tire Programmed (Tire Swap Location screen)
	Tire Normal (after coded)
	Tire Alert (after coded)
	°F / °C Temperature Unit
	PSI/BAR Pressure Unit
	Pressure Warning
	Temperature Warning
	Sensor Low Battery
	Repeater Signal
	Trailer Icon (Trailer 1 example)

## DISPLAY INSTALLATION AND CHARGING

The provided magnetic mount with suction cup base can be used on the windshield, side window or directly on smooth, nonporous surfaces. Additional magnetic mounts can also be used with the magnetic base plate on the backside of the display.

To charge the display's non-replaceable, internal lithium battery, plug the USB power cord in the provided 12v power adapter and then into the vehicle's 12v power port. Plug the USB-C end of the power cord into the side of the display. The  icon indicates you should charge the display, while , , , and , indicate battery levels.

When the battery is fully charged the  icon goes away.

**Note:** Displays with date codes earlier than 3321 will remain powered on regardless of power switch selection while connected to the USB-C charging cable. Date codes of 3321 and later will power down when the off position is selected during charging.

**Do not keep a fully charged display plugged in constantly.**

## TST-770 SYSTEM DEFAULT SETTINGS

Pressure Unit	PSI
Temperature Unit	°F
High Pressure Alert	125 PSI
Low Pressure Alert	90 PSI
High Temperature Alert	158°F
<b>Power Unit Cold Tire Pressure</b>	
Steer Axle	100 PSI
Drive Axle	100 PSI
Spare Tire	100 PSI
<b>Power Unit Manual Input High and Low Pressure Alert</b>	
High (Axle1/2/3/S)	125 PSI
Low (Axle1/2/3/S)	90 PSI
<b>Trailer Cold Tire Pressure</b>	
Trailer # 1/2/3/4/5	100 PSI
<b>Trailer Manual Input High and Low Pressure Alert</b>	
High (Axle1/2/3/S)	125 PSI
Low (Axle1/2/3/S)	90 PSI

**Note:** Default pressure settings are based on the cold tire pressure. Once the customer enters into “Manual Input High and Low Pressure Alert” to set the cold pressure manually, “System is currently using manually input high/low pressure settings” will appear on the screen.

## COLD TIRE PRESSURE (CTP) SYSTEM DEFAULT SETTINGS

Cold Tire Pressure (CTP) defaults alerts are 25% above CTP for High Pressure and 10% below CTP for Low Pressure.

<b>Example Scenarios</b>	
<b>Steer Axle</b>	<b>CTP of 100 PSI</b>
Axle 1 HIGH Alert	125 PSI (100 PSI CTP x 125% = 125 PSI)
Axle 1 LOW Alert	90 PSI (100 PSI CTP x 90% = 90 PSI)
<b>Drive Axle</b>	<b>CTP of 110 PSI</b>
Drive Axle 2/3 HIGH Alert	138 PSI (110 PSI CTP x 125% = 138 PSI)
Drive Axle 2/3 LOW Alert	99 PSI (110 PSI CTP x 90% = 99 PSI)
<b>Spare</b>	<b>CTP of 120 PSI</b>
Spare HIGH Alert	150 PSI (120 PSI CTP x 125% = 150 PSI)
Spare LOW Alert	108 PSI (120 PSI CTP x 90% = 108 PSI)

## MAIN SCREEN

Remove protective film from Display by lifting the tab in the upper right corner.

Slide power slide switch to ON position.

**Startup Screen** will appear after ~5 seconds, followed by the **Settings Icons Screen** or, if sensor(s) are already programmed, the Power Unit/Trailer **Main Screen** will appear after approximately 5 seconds.

If no sensors are paired to the Display, the **Settings Menu Screen 1** will change to the Power Unit/Trailer **Main Screen** after approximately 1 minute, 30 seconds.

**Note:** When the display receives the paired sensor information, the corresponding pressure and temperature data will be displayed on the Power Unit/Trailer **Main Screen**.

**PRODUCT NOTE:**  
GPS FEATURE  
MAY NOT BE  
AVAILABLE  
ON CERTAIN  
MODELS.



Startup Screen

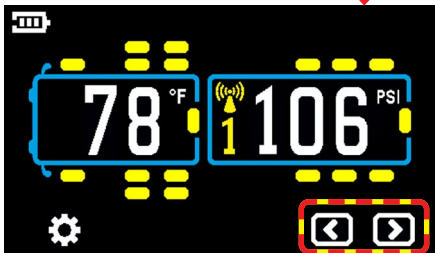

Power Unit/Trailer Main Screen  
(if sensors already programmed)



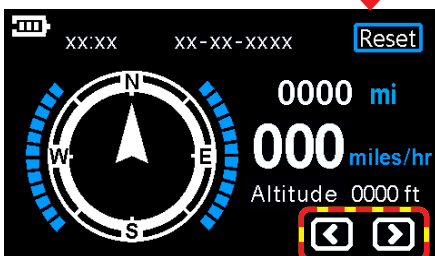

Settings Menu Screen 1  
(if no sensors are programmed)

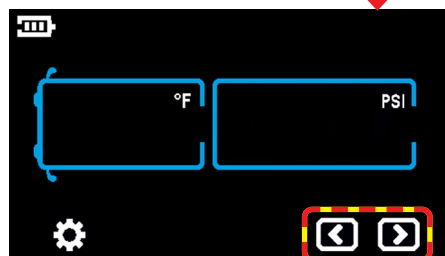

GPS Interface Screen (left and right arrows bring up GPS)  
**Note:** GPS feature may not be available on certain models)



Power Unit/Trailer Main Screen  
(appears after 1 minute, 30 seconds)

Touch  or  to switch between Power Unit/Trailer **Main Screen** and **GPS Interface Screen** (this is not a navigation tool). Please allow up to 15 minutes for the GPS to initialize the first time.

## UNDERSTANDING YOUR TIRE ALERTS

When there is an alert, the tire position will change from yellow to red, will display the corresponding alert with icons, audible alarm will sound (beep) and LED will flash red.

When you silence the alert by touching the screen, The alert will not sound again as the unit cycles back to the alert tire. The alert text continues to flash and the tire remains red. LED stays on as long as the alert is active.

If you leave the alert active it remains on the same alert tire for 10 seconds before resuming the monitoring cycle. Display does not cycle through other tires until you silence the alert.

After 10 seconds if alert has not been silenced display will continue to visually cycle through the rest of the programmed tires, keeping the alert tire in red.

**Note:** During active audible and visual alerts, all other active tires are being monitored.

### Power Unit/Trailer **Main Screen**

1. Switches to each programmed tire position every 5 seconds.
2. Displays repeater icon when receiving repeater signal.

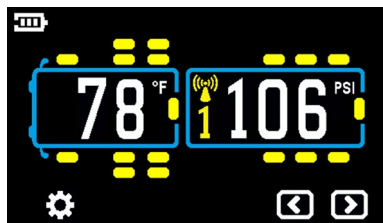

### High Pressure Alert

**Example:** High Pressure threshold is 125 PSI.

1. Tire position will start flashing red.
2. High Pressure indicator and icon will flash, once every second.
3. Audible alert will sound.

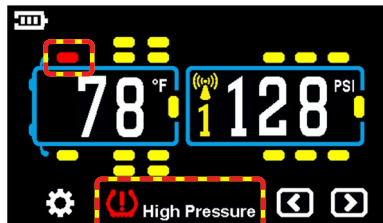

### Low Pressure Alert

**Example:** Low Pressure threshold is 90 PSI.

1. Tire position will start flashing red.
2. Low Pressure indicator and icon will flash, once every second.
3. Audible alert will sound.

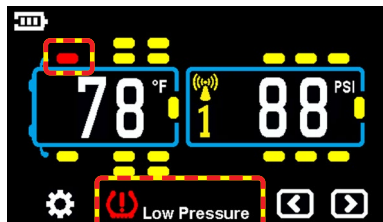

### High Temperature Alert

**Example:** High Temperature threshold is 158° F.

1. Tire position will start flashing red.
2. High Temperature indicator and icon will flash, once every second.
3. Audible alert will sound.

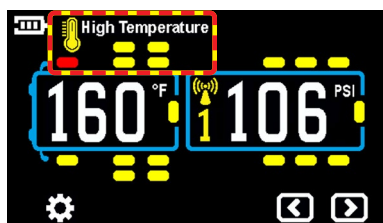

## UNDERSTANDING YOUR TIRE ALERTS (cont.)

### Sensor Low Battery Alert

**Example:** Sensor Low Battery icon shown.

1. Tire position will start flashing red.
2. Sensor Low Battery indicator and icon will flash, once every second.
3. Audible alert will sound.

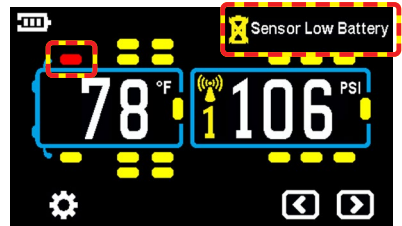

### Fast Leak Alert

**Example:** Loss of 2 PSI or greater in less than one minute.

1. Tire position will start flashing red.
2. FAST LEAK indicator and icon will flash, once every second.
3. Audible alert will sound.

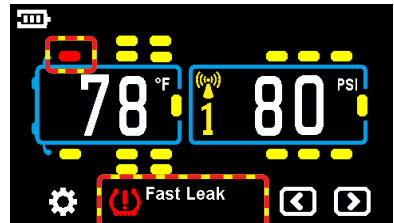

### Alerts Multiple Tire Positions

1. When there is more than one alert at the same time, display will cycle through the multiple alerts.
2. Touch screen to silence audible alert. Display will resume cycling through all programmed tire positions. You can manually select any programmed tire position by touching that tire position.

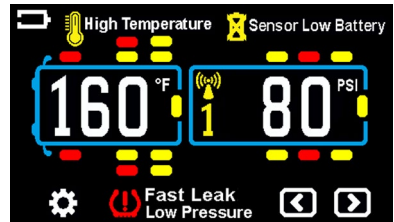

## OTHER FUNCTIONS

### Normal Display Scrolling

The tire icons will automatically scroll through. Each tire position will be displayed for approximately 5 seconds. You can manually cycle through the displayed tires by touching the tire icon on the screen.

### Back-lighting and Motion Detection

The display is equipped with a light sensor and a motion sensor. The back-light will turn on when the vehicle is in motion and there is a little ambient light. If the vehicle has been motionless for a while and the display is on the internal battery, the display will "go to sleep" until the vehicle resumes motion.

### Display Sleep Mode

When the display detects no motion for 10 minutes, it will enter into sleep mode automatically, the screen turns off until motion is detected.

### Display Auto-hide

If the display does not receive data from paired sensors, power unit or trailer for 15 consecutive minutes, the display will automatically "hide" those sensors. Sensors will appear when they are in range.

## PARAMETER SETTINGS

**Note:** If Display senses no input for 90 seconds, it will exit to **Main Screen** automatically.

To adjust Default Settings, touch main screen settings icon  to enter into **Settings Menu Screen 1**. This will be the first step for the remaining sections.

Touch  or  to switch between **Settings Menu Screen 1** or **Settings Menu Screen 2**.

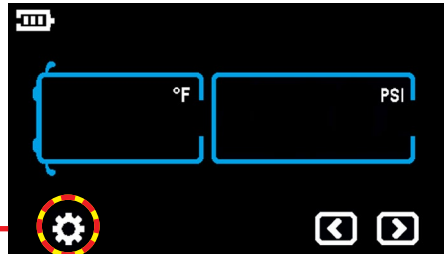

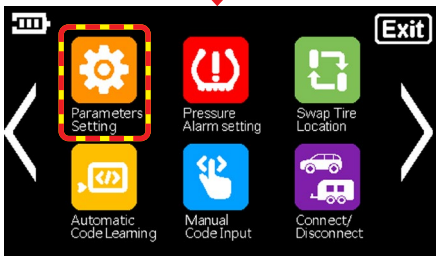

Power Unit/Trailer Main Screen

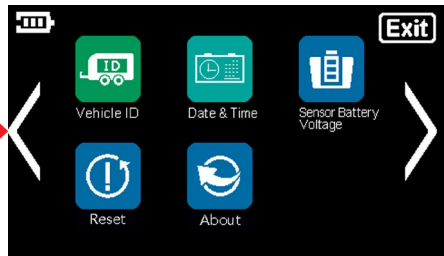

Settings Menu Screen 1



Settings Menu Screen 2

Touch  to enter into Parameters Settings. Touch  or  to switch between **Parameter Settings Screen 1** or **Parameter Settings Screen 2**. Change options by selecting Pressure, Temperature, High Temp Alert, Speed, Clock, Altitude.

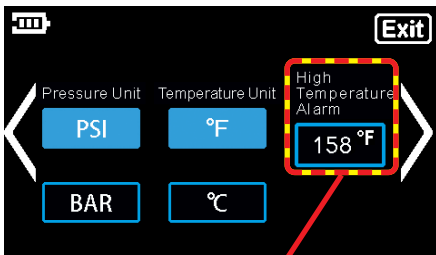

Parameter Settings Screen 1

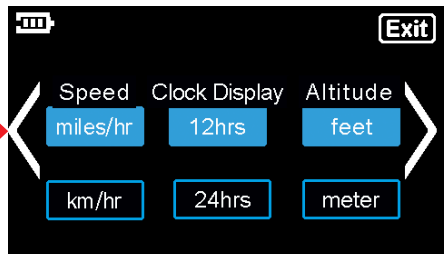

Parameter Settings Screen 2

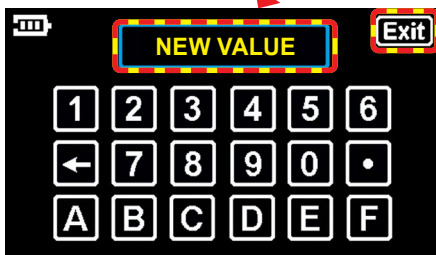

Keyboard Input Screen

**Example:** To change High Temperature Alert (default is 158°F) touch the High Temp Alert unit and use the **Keyboard Input Screen** to change setting. Touch **Exit** to return to **Parameters Settings** screen. Touch **Exit** again.

To save your input, touch **Exit and Save**. To cancel, touch **Exit without Saving**. Selection returns you to **Main Screen**.

## COLD TIRE PRESSURE ALERT SETTINGS - POWER UNIT

The following instructions will utilize the **Default** High/Low Pressure Alert thresholds. For **Manual High/Low Pressure Alert** thresholds, go to page 13.

**Note:** When inputting **Cold Tire Pressure (CTP)** with this option, **High Pressure Alert** will be set at 25% above CTP and **Low Pressure Alert** will automatically be set at 10% below CTP.

To adjust **Cold Tire Pressure** settings, touch  to enter into **Pressure Alert Settings**. Touch  to enter **Power Unit Cold Pressure** screen.

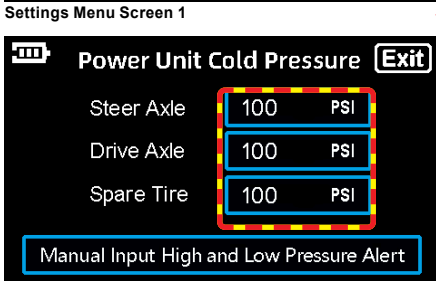
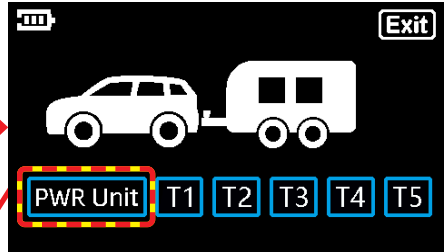
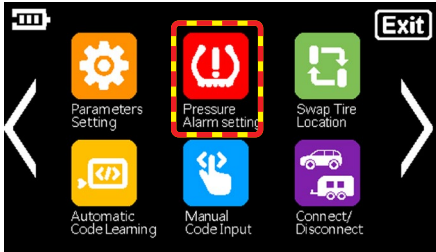

To set **Steer Axle**, **Both Drive Axles** and **Spare Tire** cold tire pressure, touch  to enter the **Keyboard Input Screen**. Enter your preferred Cold Tire Pressure.

**Note:** If Drive Axles require different pressure settings please refer to Page 13 **Manual Setup**.

Touch  to exit **Keyboard Input Screen** after Steer Axle, Drive Axle and Spare Tire cold tire pressure settings are changed. **Power Unit Cold Pressure** screen will appear.

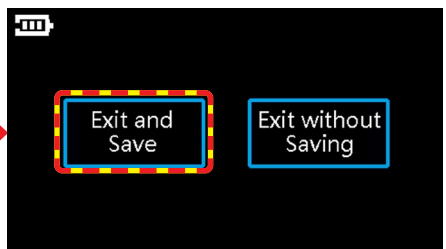
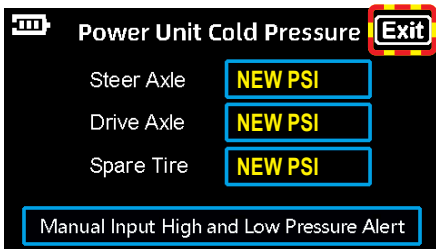

Touch  again to exit **Power Unit Cold Pressure** screen. To save your input, touch **Exit and Save**. To cancel, touch **Exit without Saving**. Selection returns you to the Power Unit/Trailer **Main Screen**.

## COLD TIRE PRESSURE ALERT SETTINGS - TRAILERS

The following instructions will utilize the **Default** High/Low Pressure Alert thresholds. For **Manual** High/Low Pressure Alert thresholds, go to page 13.

**Note:** When inputting **Cold Tire Pressure** (CTP) with this option, **High Pressure Alert** will be set at 25% above CTP and **Low Pressure Alert** will automatically be set at 10% below CTP.

To adjust default **Cold Tire Pressure** settings, touch  to enter into **Pressure Alert Settings**. Touch **T1**, **T2**, **T3**, **T4** or **T5** to enter **Trailer Cold Pressure** screen.

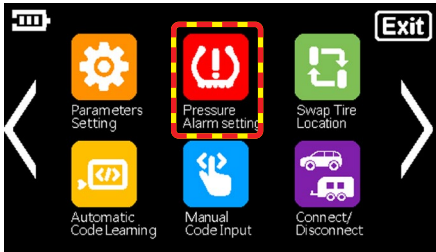

Settings Menu Screen 1

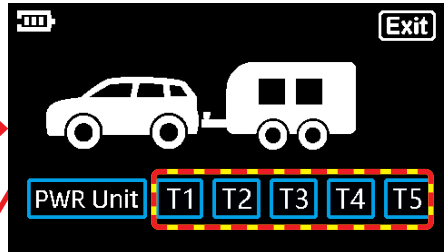

Power Unit or Trailer Selection Screen

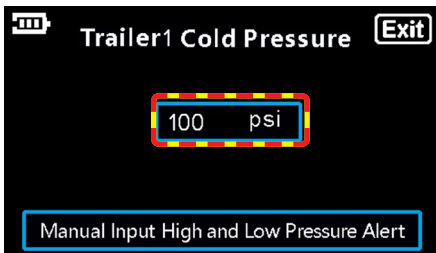

Trailer 1 Cold Pressure Screen



Keyboard Input Screen

To set **Trailer Axle** cold tire pressure, touch  to enter the **Keyboard Input Screen**. Enter your preferred Cold Tire Pressure.

Touch  to exit **Keyboard Input Screen** after **Trailer Axle** cold tire pressure settings are changed. **Trailer Axle Cold Pressure** screen will appear.



Trailer Axle Cold Pressure Screen

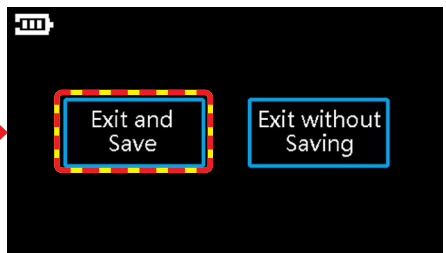

Exit and Save or Exit Without Saving

Touch  again to exit **Trailer Axle Cold Pressure** screen. To save your input, touch **Exit and Save**. To cancel, touch **Exit without Saving**. Selection returns you to the Power Unit/Trailer **Main Screen**.

## MANUAL HIGH/LOW PRESSURE ALERT SETTINGS

**Note:** **High Pressure Alert** defaults are set at 25% above Cold Tire Pressure setting and **Low Pressure Alert** will be set at 10% below Cold Tire Pressure setting.

To manually adjust **High and Low Pressure Alert** values, touch  to enter into **Pressure Alert Settings**. Touch **Power Unit**, **T1**, **T2**, **T3**, **T4** or **T5** to enter respective **Cold Pressure** screen. **Example:** Touch **T1**.



Settings Menu Screen 1

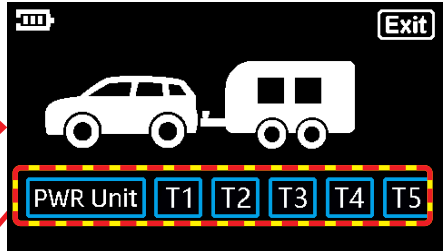

Power Unit or Trailer Selection Screen

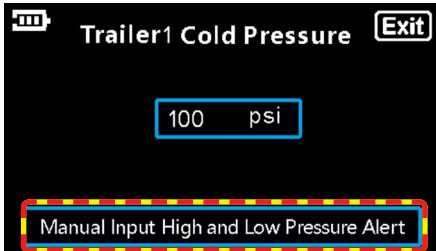

Trailer 1 Cold Pressure Screen (Example)

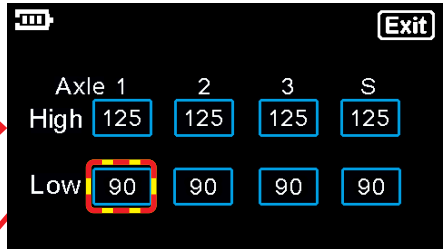

Manual Input High/Low Pressure Alert Value Screen

Touch **Manual Input High and Low Pressure Alert** to enter the **Manual Input High/Low Pressure Alert Value** screen. **NOTE: LOW SETTING MUST BE ADJUSTED PRIOR TO HIGH SETTING.**

To change **Pressure Alert Value**, touch the box that corresponds to the axle you would like to change (1, 2, 3 or Spare).



Keyboard Input Screen

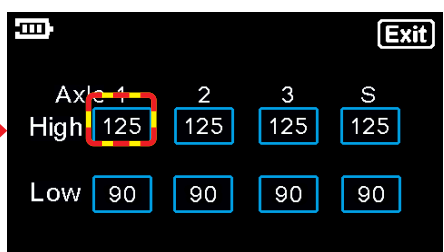

Manual Input High/Low Pressure Alert Value Screen

This will bring up the **Keyboard Input Screen**. Enter your preferred **Low Pressure Alert Value**. Touch **Exit** to exit **Keyboard Input Screen** and repeat steps for remaining **Pressure Alert Value** for this axle and then repeat for the remaining axles and spares.

Touch **Exit** again to exit **Manual Input High/Low Pressure Alert Value** screen. To save your input, touch **Exit and Save**. To cancel, touch **Exit without Saving**. Selection returns you to the Power Unit/Trailer **Main Screen**.

## SWAP TIRE LOCATION

**Note:** Only tires with paired sensors can be swapped. In the **Swap Tire Location** screen currently programmed tires will show as solid green color.

Touch  to enter into **Swap Tire Location** settings.

Touch  to enter **Power Unit Tire Position** settings.



Settings Menu Screen 1

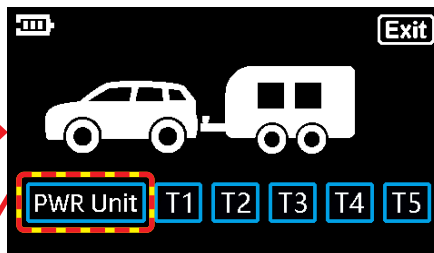

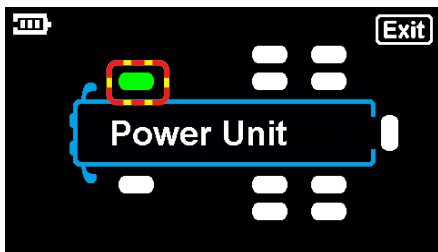

Power Unit or Trailer Selection Screen



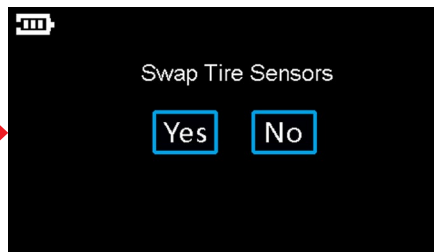

Power Unit Swap Tire Sensors Screen







Swap Tire Sensors Screen

Touch  to select the tire you want to swap (selected tire will flash green). Touch the  icon for the tire you want to swap to (both tires will flash green). **Swap Tire Sensors** screen will appear.

Touch  to save selected tire swap and exit to **Main Screen**. Touch  to cancel selected tire swap and exit to **Main Screen**.

### Swap Tire Location for Trailers

Touch  to enter into **Swap Tire Location** settings.

Touch , , ,  or  on the **Swap Tire Sensors** screen to swap trailer tire location, and repeat power unit steps above.

## AUTOMATIC CODE LEARNING

Touch **Settings** to enter into **Automatic Code Learning** settings.

Touch **Power Unit** to enter **Sensor Code Learning** settings for power unit.



Settings Menu Screen 1

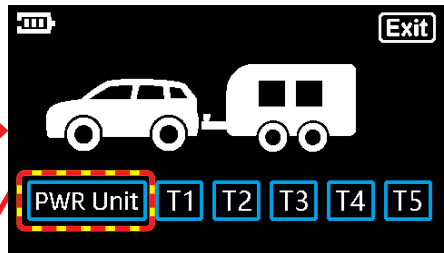

Power Unit or Trailer Selection Screen

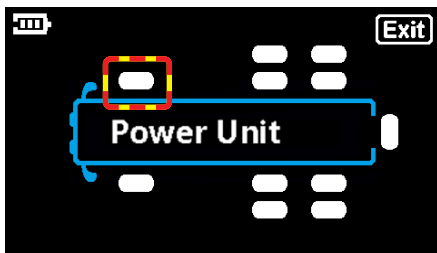

Power Unit Tire Position Screen

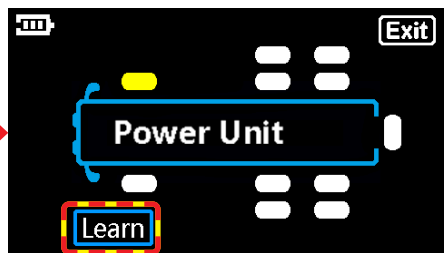

Power Unit Tire Position Screen

Touch **[Tire Icon]** to select the tire you want to code to the sensor. Selected tire will flash white and yellow and the **Learn** icon will appear on the screen.

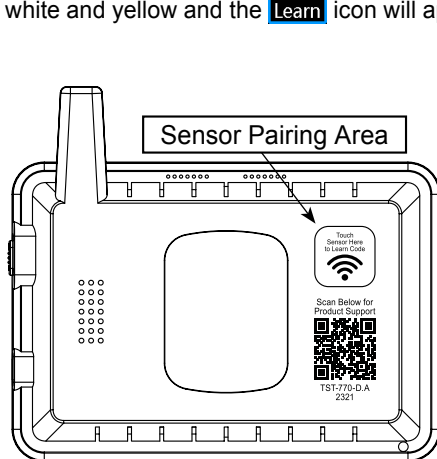

Back of TST-770 Display

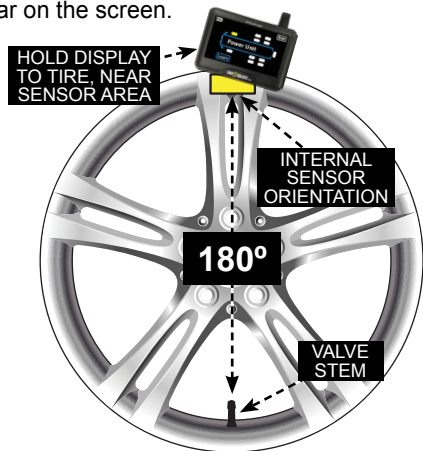

Internal Sensor Position is 180° from Valve Stem

Touch **Learn** icon. Icon will change to **Learn**. Touch a sensor to the **Sensor Pairing Area** on back of the display (see image above) to learn sensor ID code.

**Note:** For internal sensor hold the **Sensor Pairing Area** to the tire, at the sensor location, which is located 180° from the valve stem (see image above).

## AUTOMATIC CODE LEARNING (cont.)

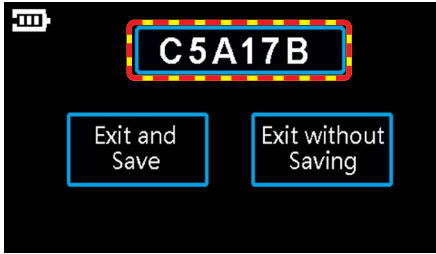

Sensor Code Capture Screen

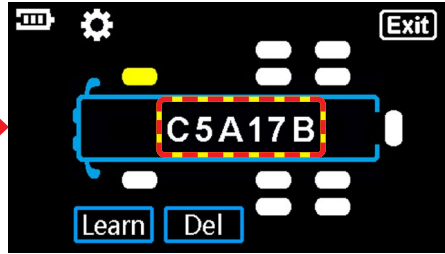

Power Unit Sensor Code Learning Screen

If sensor code learning is successful, sensor ID code (Example: C5A17B) will appear on **Sensor Code Capture** screen with options to **Exit and Save**.

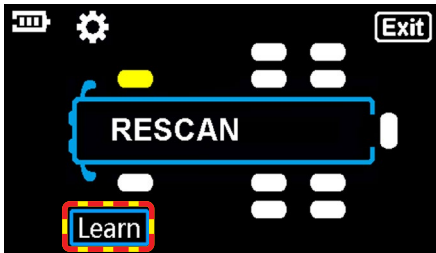

Power Unit Sensor Code Learning Screen

**Note:** If sensor code learning is unsuccessful, **RESCAN** will appear on **Sensor Code Learning** screen (after ~10 seconds). Touch **Learn** icon to attempt to learn sensor code again. Repeat above steps until sensor is coded.

After successful code learning, touch **Exit and Save** to return to sensor code learning screen. The programmed tire position will blink yellow and sensor code will show (Example: C5A17B) in power unit on **Sensor Code Learning** screen.

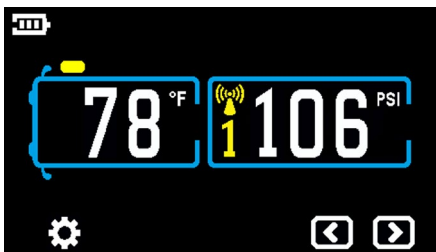

Power Unit/Trailer **Main Screen** (after 1st sensor learning)

**Note:** If the Cold Tire Pressure (CTP) has not yet been set, the tire positions will flash red and alerts will sound. Tap the screen to silence, touch main screen settings icon  to get to the main screen and follow **Cold Tire Pressure Alert** settings instructions on pages 11-12.

Repeat for remaining tire positions.

Touch **Exit** to finish and return to **Main Screen**. Learned code tire positions will blink yellow and will show pressure and temperature readings.

### Automatic Code Learning for Trailers

Touch  to enter into **Automatic Code Learning** settings.

Touch **T1**, **T2**, **T3**, **T4** or **T5** to enter **Sensor Code Learning** settings for respective trailers and repeat previous power unit steps.

## CONNECT/DISCONNECT

**Note:** This example shows Trailer Units. All connected units will show as blue icons with white text.

Touch  to enter into **Connect/Disconnect Tire** settings.

Touch **T1**, **T2**, **T3**, **T4** or **T5** on the **Connect/Disconnect Tire** screen.

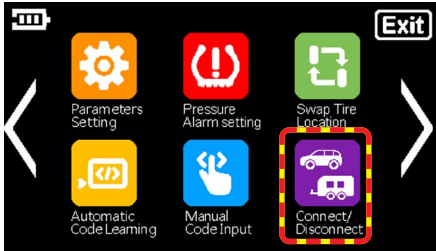

Settings Menu Screen 1

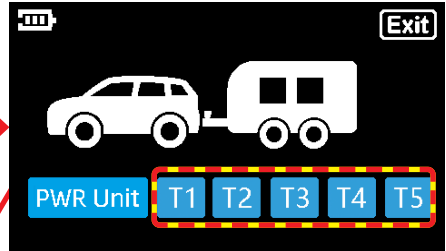

Power Unit or Trailer Connect/Disconnect Screen

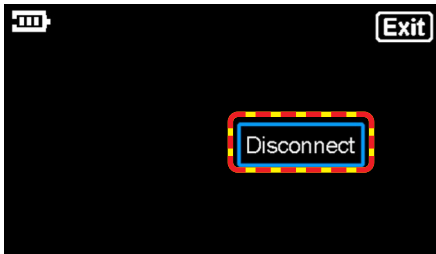

Power Unit/Trailer Unit Disconnect Screen

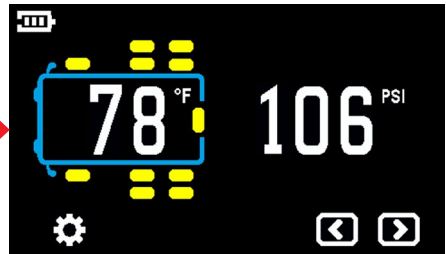



Power Unit/Trailer Main Screen

Touch  to disconnect the trailer selected. then select **Exit** and **Save**. **Main Screen** will now show the unit disconnected.

## CUSTOM VEHICLE ID

**Note:** If Display senses no input for 90 seconds, it will exit to **Main Screen** automatically.

To adjust Default Settings, touch main screen settings icon  to enter into **Settings Menu Screen 1**. Touch  to switch to **Settings Menu Screen 2**. This will be the first step for the remaining sections.

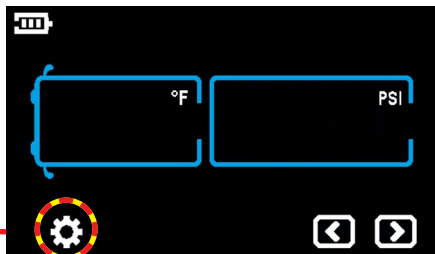

Power Unit/Trailer Main Screen



Settings Menu Screen 1

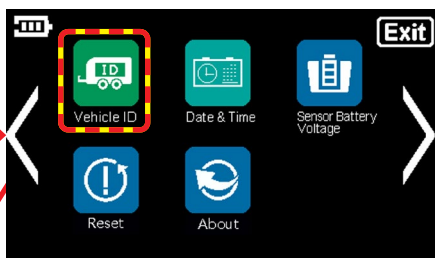

Settings Menu Screen 2

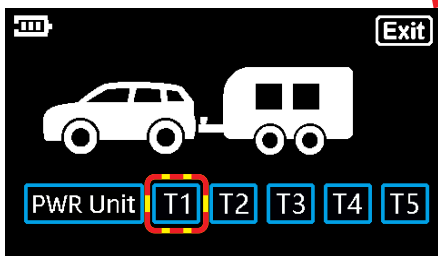

Power Unit or Trailer Selection Screen

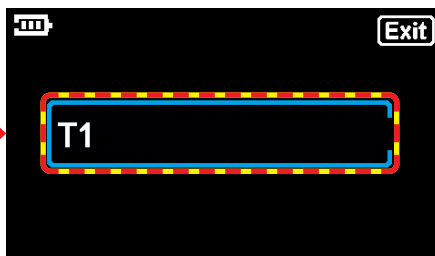

Trailer 1 Vehicle ID Screen

Touch  to enter into **Vehicle ID** settings.

**Note:** This example shows Trailer 1.

Touch **T1**, **T2**, **T3**, **T4** or **T5** to enter **Vehicle ID** settings for respective trailer.

Touch **T1**  to enter **Full Keyboard Input** screen

## CUSTOM VEHICLE ID (cont.)

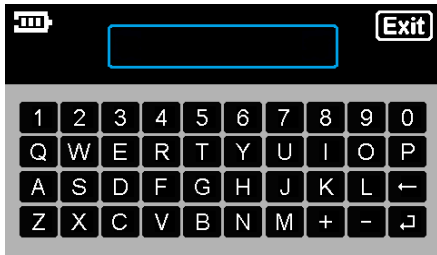

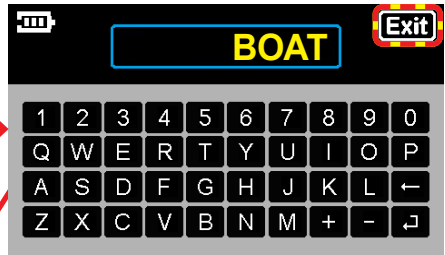

Full Keyboard Input Screen



Full Keyboard Input Screen

Enter new name for Trailer 1. **Example:** "BOAT".

Touch  to delete character.

Touch  or  to exit **Full Keyboard Input** screen after vehicle ID settings are changed.

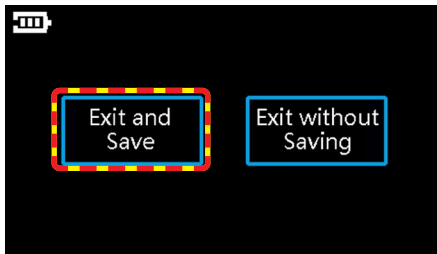

Exit and Save or Exit Without Saving Screen

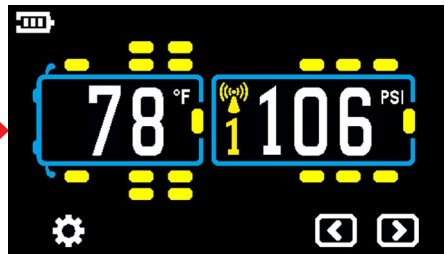





Power Unit/Trailer Main Screen

To save your input, touch **Exit and Save**. To cancel, touch **Exit without Saving**. Selection returns you to the Power Unit/Trailer **Main Screen**.

### Custom Vehicle ID's for Remaining Trailers and Power Unit.

Touch  to enter into **Vehicle ID** settings.

Touch , , ,  or  to enter **Vehicle ID** settings for remaining trailers or power unit and repeat previous steps to change Vehicle ID.

## DATE & TIME SETTINGS

**Note:** Default Time Zone is set to CST(UTC-06:00).

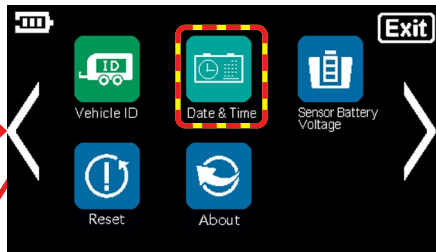

Settings Menu Screen 1

Settings Menu Screen 2

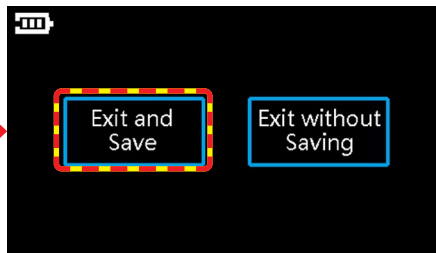
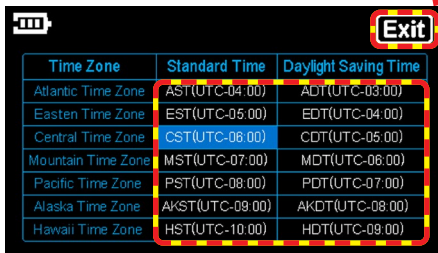

Power Unit or Trailer Selection Screen

Exit and Save or Exit Without Saving Screen

To change your preferred **Time Zone**, touch to enter into **Date & Time** settings.

Touch the preferred **Time Zone** in the available menu.

Touch to exit **Time Zone** screen. To save your input, touch **Exit and Save**. To cancel, touch **Exit without Saving**. Selection returns you to the Power Unit/Trailer **Main Screen**.

**Note:** GPS automatically sets Date and Time. No further adjustment is necessary. Please allow up to 5 minutes for the unit to capture satellites and begin to report.

**Note:** GPS feature may not be available on certain models.

## SENSOR BATTERY VOLTAGE

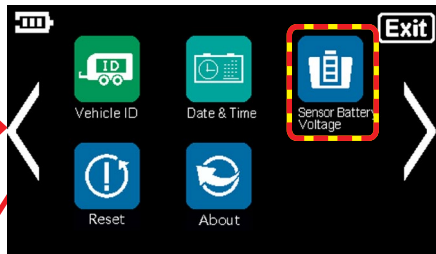

Settings Menu Screen 2

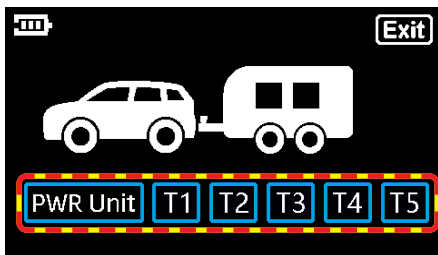

Power Unit or Trailer Selection Screen

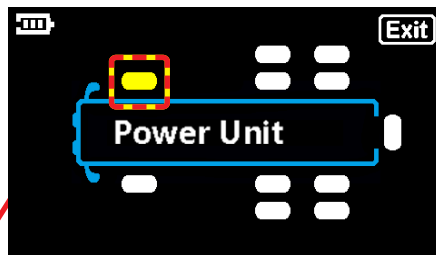

Power Unit Tire Position Screen

Touch  to check into **Sensor Battery Voltage**.

Touch **T1**, **T2**, **T3**, **T4**, **T5** or **Power Unit** to view **Sensor Battery Voltage** readings for respective trailers or power unit.

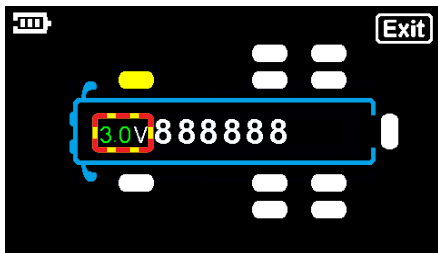

Touch any  icon to check the sensor voltage.



Power Unit Tire Position Screen

### Sensor Battery Voltage Number Key

A numeric voltage value will be displayed in one of 3 colors:

	Battery in Good Condition
	Battery is Marginal
	Replace Battery or Internal Sensor





**Sensor Battery Voltage** will be shown, along with selected tire position and sensor and ID code.

Touch **Exit** to return to the Power Unit/Trailer **Main Screen**.

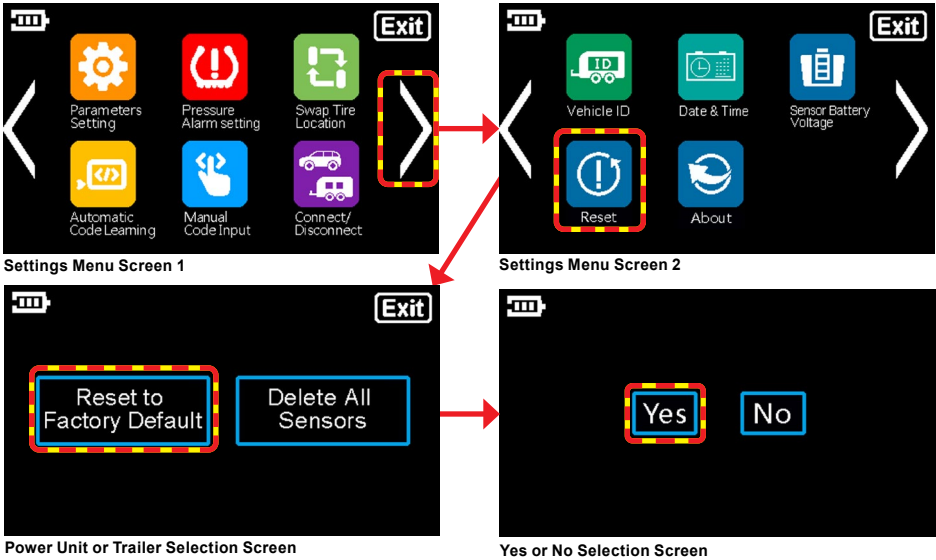
## RESET





### To Reset System to Factory Defaults:

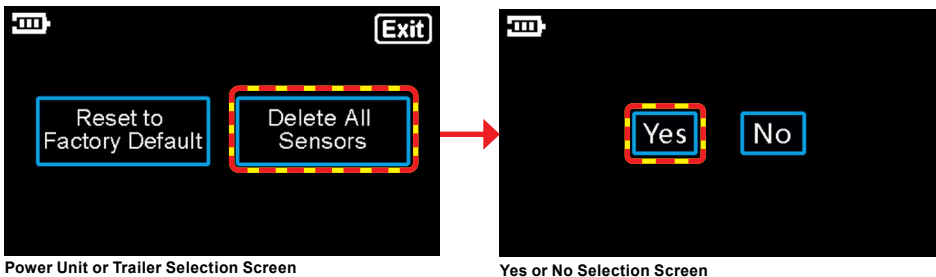

To reset the system to factory default settings, touch  to enter into **Reset** screen. Touch  to **Reset To Factory Default**. Touch  to reset to factory default settings. Touch  to exit without changes. Both options will return to **Main Screen**.



### To Delete All Sensors (and retain any user-modified parameter settings):

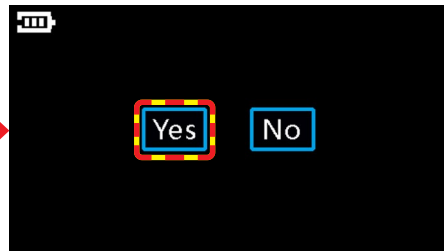
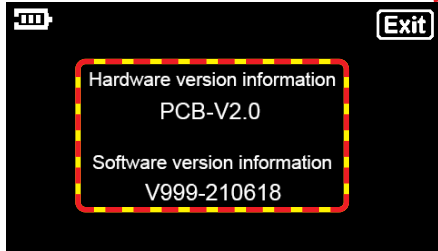
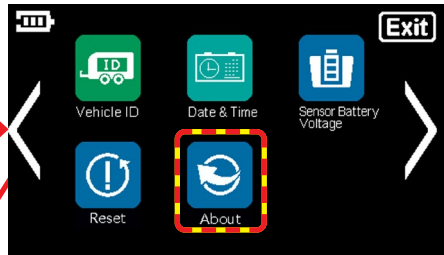

To **Delete All Sensors**, touch  to enter into **Reset** screen. Touch  to **Delete All Sensors**. Touch  to delete all programmed sensors. Touch  to exit without changes. Both options will return to **Main Screen**.

## ABOUT



To review system information, touch  to enter into **About** screen. About menu will display current Hardware and Software Version Information. Touch  to return to the Power Unit/Trailer **Main Screen**.

## SENSOR INSTALLATION - CAP SENSOR

1. Screw the hex nut onto the valve stem threads until it bottoms out. The hex nut is not required, but is provided as a theft deterrent.
2. Screw the correctly marked sensor onto the valve stem for that tire position. Tighten the sensor until the air stops leaking and the sensor bottoms-out on the valve stem. Then give it a quarter turn more to seat it. **Do Not Over Tighten!**
3. Use your fingers to screw the hex nut up to the bottom of the sensor. Using the provided wrench, tighten the hex nut against the bottom of the sensor. This will prevent the sensor from being removed. Keep the wrench in a safe place for future use.
4. To inflate or deflate the tire, you must remove the cap sensor.

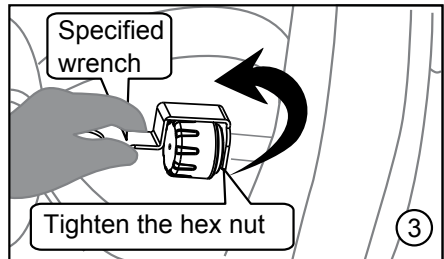
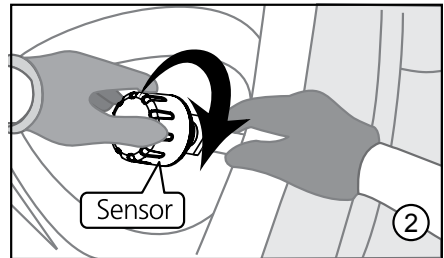
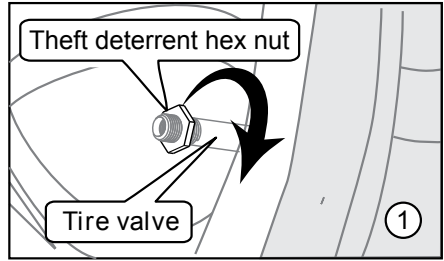

### TST Hybrid/Marine Cap Sensor



(Contains non-replaceable battery CR2450 3V)

**Note:** Hybrid/Marine Sensors require metal valve stems.

## SENSOR INSTALLATION - FLOW-THRU SENSOR

**Note:** Flow-thru Sensors require metal valve stems.

1. Screw the hex nut onto the valve stem threads until it bottoms out. The hex nut is not required, but is provided as a theft deterrent.
2. Screw the correctly marked sensor onto the valve stem for that tire position. Tighten the sensor until the air stops leaking and the sensor bottoms-out on the valve stem. Then give it a quarter turn more to seat it. **Do Not Over Tighten!**
3. Use your fingers to screw the hex nut up to the bottom of the sensor. Using the provided wrench, tighten the hex nut against the bottom of the sensor. This will prevent the sensor from being removed. Keep the wrench in a safe place for future use.
4. You can now inflate or deflate the tire through the 507FT sensor without removing it.

- ① Install the theft deterrent hex nut onto the tire

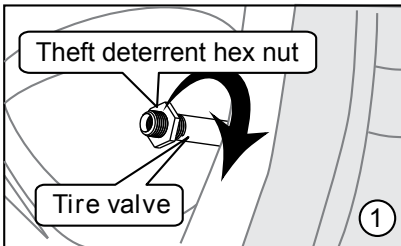

- ② Install the sensor onto the tire valve clockwise.

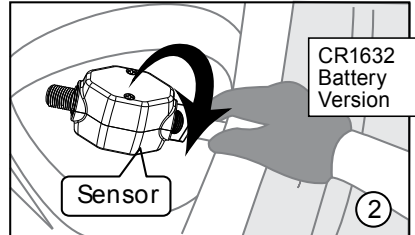

- ③ Tighten the hex nut counterclockwise until the nut is tightened against the sensor.

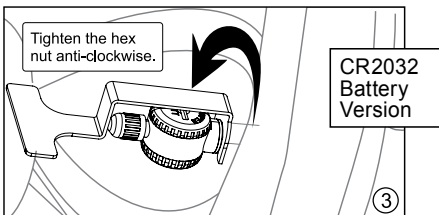
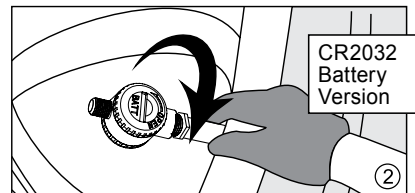
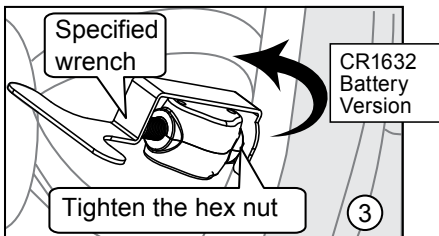

- ④ Install the sensor valve cap onto the sensor.

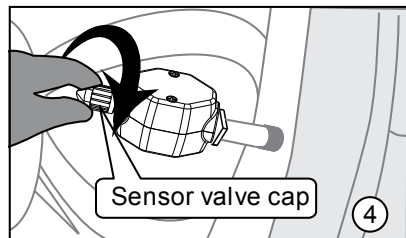

## SENSOR PREPARATION - INTERNAL SENSORS

Always consult with a Certified Safety Consultant prior to any installation procedures. Read and understand all instructions and procedures before service to components begins.

**NOTE:** Identify your Internal Sensor type using page 4 image examples and follow steps 1-4 for your specific sensor. Steps 5-9 are common.

1. Remove the wheel from the vehicle and deflate the tire.
2. Remove the tire from the wheel.

Prepare **SCREW-MOUNTED SENSORS**:

3. If the sensor is not already attached to the band, attach the sensor to the sensor band with the two screws. Torque the screws to 10-12 in-lbs (1.1-1.4Nm). See *Figure 1*.
4. Put the sensor and sensor band in the **center position** (sometimes known as the “well”) of the wheel hub. See *Figure 2*.

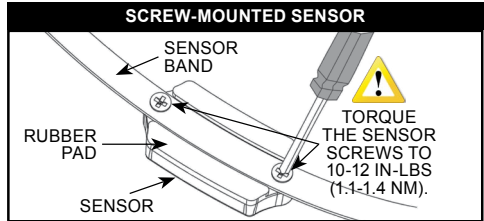

Figure 1: Screw-mounted internal sensor

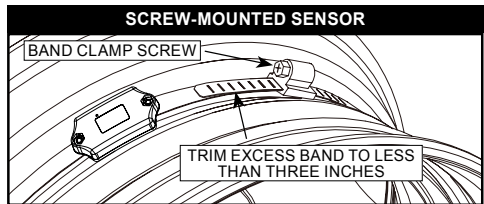

Figure 2: Screw-mounted Internal sensor final install

Prepare **SLIDE-ON SENSORS**:

3. Pass the end of the band through the sensor and slide sensor to within a few inches of the band clamp screw. See *Figure 3*.
4. Put the sensor and band clamp in the **center position** of the wheel hub and pass the band through the band clamp screw, then again through the belt-mounted sensor. See *Figure 4*.

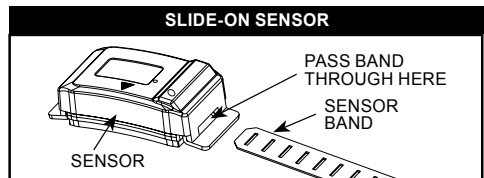

Figure 3: Feed band through sensor

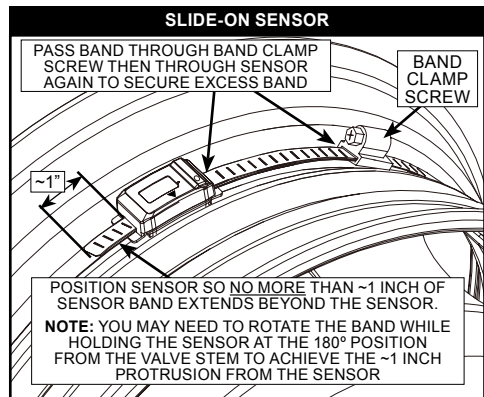

Figure 4: Slide-on internal sensor final install

## SENSOR INSTALLATION TO WHEEL - INTERNAL SENSORS

**!** **IMPORTANT:** Sensor should be installed 180 degrees from the tire valve stem. See Figure 5.

**!** **CAUTION:** MAKE SURE THE SENSOR BAND IS CORRECTLY INSTALLED ON THE WHEEL HUB AND DOES NOT MOVE Laterally OR ROTATE. See Figure 5.

5. Tighten the band clamp on the wheel hub. Ensure sensor does not move laterally or rotate on wheel hub. See Figures 2, 4 and 5.

**!** **IMPORTANT:** To avoid damage to the tire bead as the tire is mounted to the wheel:

1) On **SCREW-MOUNTED SENSOR**, trim excess band. Do not let the trimmed end of the band protrude away from the wheel. See Figure 2.

2) On **SLIDE-ON SENSOR** position the sensor to secure the tail. See Figure 4.

6. Torque the band clamp screw to 40 in-lbs (4.5 Nm). See Figure 6.
7. Install the tire onto the wheel and inflate to the manufacturer's recommended pressure.
8. Check the tire balance per the tire balance machine instructions.
9. Install the wheel/tire assembly onto the vehicle per manufacturer's instructions.

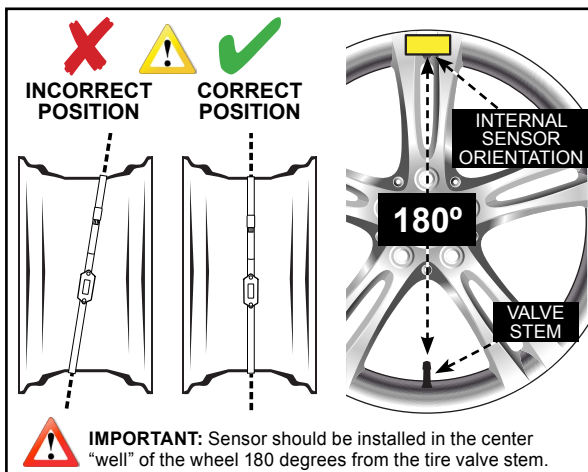

Figure 5: Internal sensor installed orientation

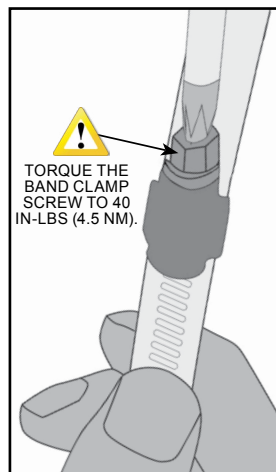

Figure 6: Band clamp screw torque

## DUAL WHEEL INSTALLATION - INTERNAL SENSORS

Always consult with a Certified Safety Consultant prior to any installation procedures. Read and understand all instructions and procedures before service to components begins.

### Recommended installation orientation for Internal Sensor TPMS-equipped Dual Wheel Vehicles

1. Please review the following instructions to ensure proper orientation of internal TPMS Sensors using the 180° valve stem orientation method. See Figure 1.

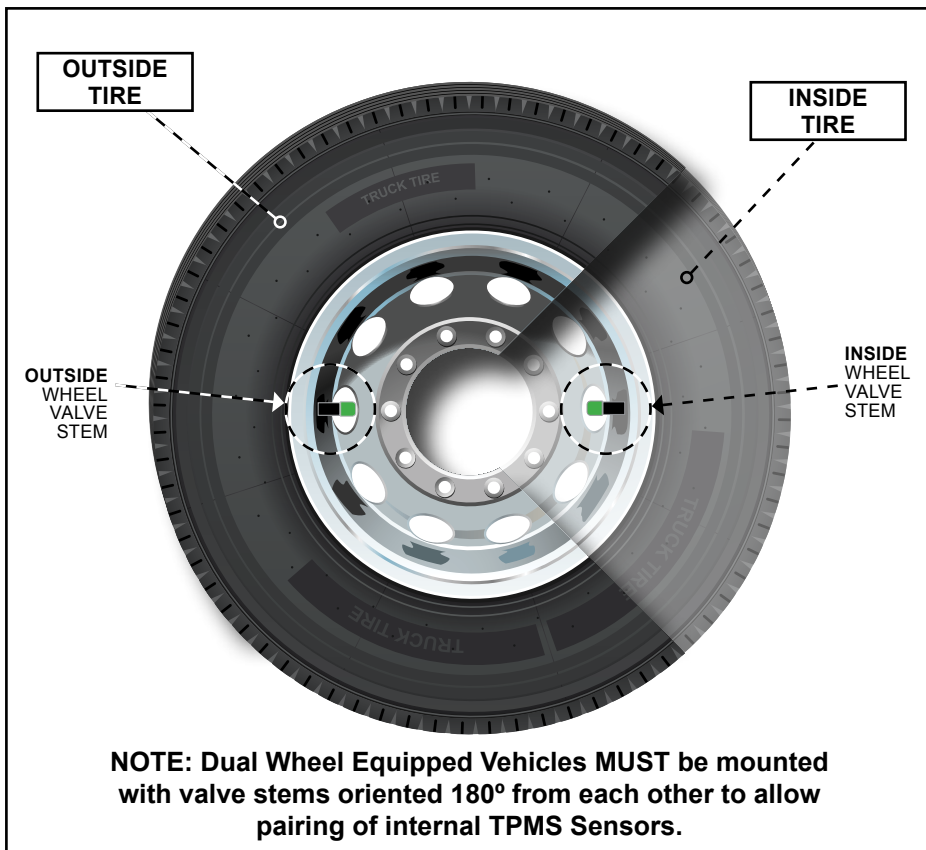

Figure 1: 180° valve stem orientation for dual wheel vehicles.

## REPLACING THE FLOW-THRU SENSOR BATTERY (CR1632 3V)

### ⚠ WARNING

- **INGESTION HAZARD:** This product contains button cell or coin battery.
- **DEATH** or serious injury can occur if ingested.
- A swallowed button cell or coin battery can cause **Internal Chemical Burns** in as little as **2 hours**.
- **KEEP** new and used batteries **OUT OF REACH** of **CHILDREN**.
- **Seek immediate medical attention** if a battery is suspected to be swallowed or inserted inside any part of the body.



**BATTERY CAUTION:** Ensure the batteries are installed correctly according to polarity (+ and -). Do not mix old and new batteries, different brands or types of batteries, such as alkaline, carbon-zinc, or rechargeable batteries. Remove and immediately recycle or dispose of batteries from equipment not used for an extended period of time according to local regulations. Always completely secure the battery compartment. If the battery compartment does not close securely, stop using the product, remove the batteries, and keep them away from children.

1. Remove the sensor from the metal valve stem.
2. Using a #00 Phillip's screwdriver, remove the two screws from the battery cover on the side of the sensor. The "+" side of the battery can now be seen.
3. Remove the battery and check that the metal contact points in the sensor are not corroded. To clean the contact points, use a pencil eraser and lightly rub the two metal battery contacts in the sensor.
4. Replace with a new CR1632 battery. Be sure the "+" (positive) side is facing out.

**Note:** It is recommended that you check the voltage of the new battery before installation. It should read 3.0 volts or greater when new.

5. Replace the "O" ring that surrounds the battery compartment. Additional "O" rings are provided in your kit or can be purchased from TST by calling 770-889-9102.
6. After the new battery and "O" ring installation replace the battery compartment cover and snugly tighten the two screws. Do not Over Tighten.
7. Screw the sensor on to the correct tire position.

**Note:** Changing the battery in the sensor does NOT effect the sensor programming in the display. You will not have to reprogram the sensor into the display.

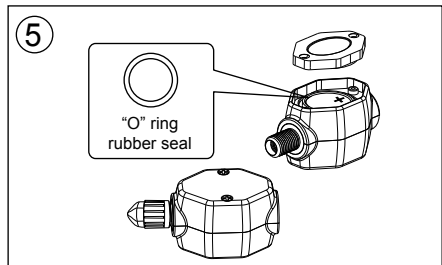
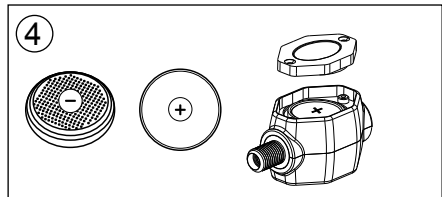
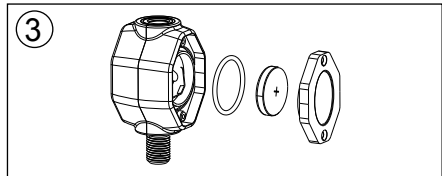
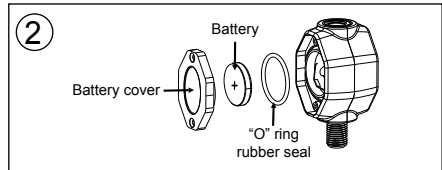

## REPLACING THE FLOW-THRU SENSOR BATTERY (CR2032 3V)

### ⚠ WARNING

- **INGESTION HAZARD:** This product contains button cell or coin battery.
- **DEATH** or serious injury can occur if ingested.
- A swallowed button cell or coin battery can cause **Internal Chemical Burns** in as little as **2 hours**.
- **KEEP** new and used batteries **OUT OF REACH** of **CHILDREN**.
- **Seek immediate medical attention** if a battery is suspected to be swallowed or inserted inside any part of the body.



**BATTERY CAUTION:** Ensure the batteries are installed correctly according to polarity (+ and -). Do not mix old and new batteries, different brands or types of batteries, such as alkaline, carbon-zinc, or rechargeable batteries. Remove and immediately recycle or dispose of batteries from equipment not used for an extended period of time according to local regulations. Always completely secure the battery compartment. If the battery compartment does not close securely, stop using the product, remove the batteries, and keep them away from children.

1. Remove the sensor from the metal valve stem.
2. Using the specified wrench, screw off the battery cover counterclockwise. The "+" side of the battery can now be seen. Take out the battery.
3. Replace with a new CR2032 battery. Be sure the "+" (positive) side is facing out.

**Note:** It is recommended that you check the voltage of the new battery before installation. It should read 3.0 volts or greater when new.

4. Replace the "O" ring that surrounds the battery compartment. Additional "O" rings are provided in your kit or can be purchased from TST by calling 770-889-9102.
5. After the new battery and "O" ring installation replace the battery compartment cover screwing clockwise using the specified wrench. Do not Over Tighten.
6. Screw the sensor on to the correct tire position.

**Note:** Changing the battery in the sensor does NOT effect the sensor programming in the display. You will not have to reprogram the sensor into the display.

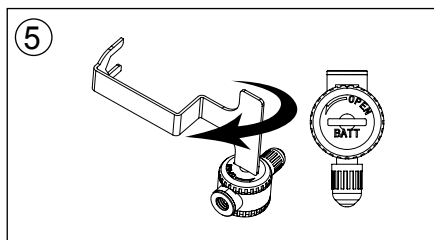
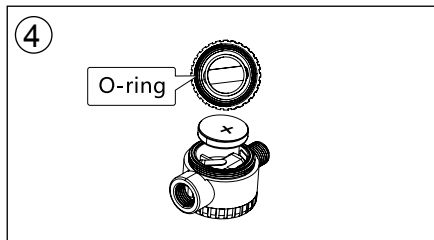
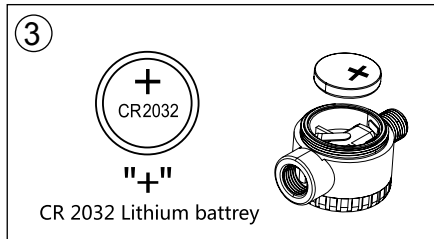
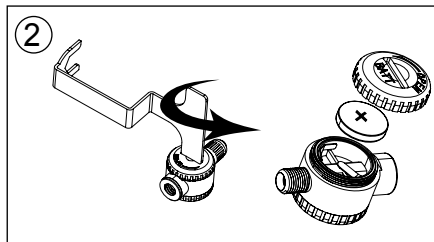

## REPLACING THE CAP SENSOR BATTERY (CR2032 3V)

### ⚠ WARNING

- **INGESTION HAZARD:** This product contains button cell or coin battery.
- **DEATH** or serious injury can occur if ingested.
- A swallowed button cell or coin battery can cause **Internal Chemical Burns** in as little as **2 hours**.
- **KEEP** new and used batteries **OUT OF REACH** of **CHILDREN**.
- **Seek immediate medical attention** if a battery is suspected to be swallowed or inserted inside any part of the body.



**BATTERY CAUTION:** Ensure the batteries are installed correctly according to polarity (+ and -). Do not mix old and new batteries, different brands or types of batteries, such as alkaline, carbon-zinc, or rechargeable batteries. Remove and immediately recycle or dispose of batteries from equipment not used for an extended period of time according to local regulations. Always completely secure the battery compartment. If the battery compartment does not close securely, stop using the product, remove the batteries, and keep them away from children.

1. Remove the sensor from the tire valve stem.
2. Use the specified wrench to open the sensor cap counterclockwise.
3. Slide the battery out of the cage sideways. Note that the (+) side is up. Replace with a new CR2032 battery.

**Note:** It is recommended that you check the voltage of the new battery before installation. It should read 3 volts or greater when new.

4. At this time replace the “O” ring at the base of the threads. Be sure it seated properly in it’s place.
5. After the new battery and “O” ring installation replace the battery compartment cover screwing clockwise using the specified wrench. Do not Over Tighten.
6. Screw the sensor on to the correct tire position.

**Note:** Changing the battery in the sensor does NOT effect the sensor programming in the display. You will not have to reprogram the sensor into the display.

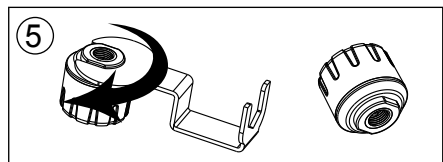
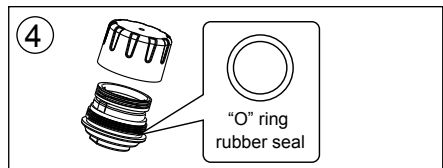
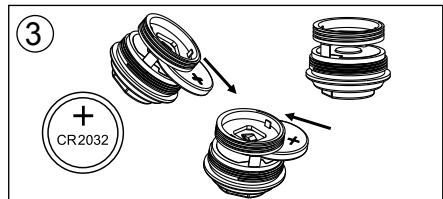
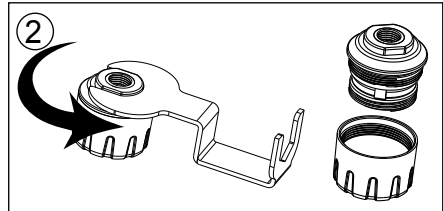
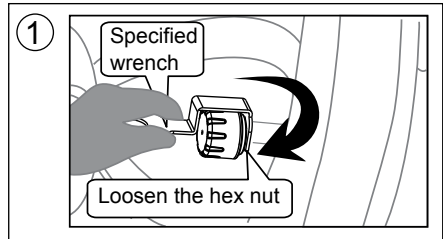

## REPEATER

The repeater is an integral component to your TPMS system.

**Failure to install the repeater could void the warranty coverage.**

The repeater is used to strengthen/amplify the sensor signal to the display. A repeater is packaged with this system.

1. The repeater is wired to a 12V source that will be constant while driving.
2. The repeater comes with two wires, one red (+) and one black (-). Simply connect the red wire to a positive source and black wire to a ground or negative source.
3. The repeater is weather resistant. No additional setup is needed for the repeater.

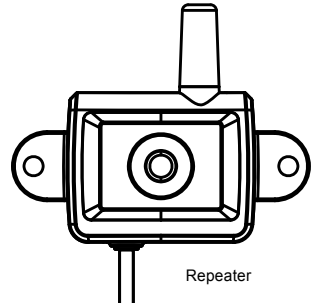

### Motorhome Installation

We recommend installing the repeater in one of the rear basement compartments where there is a 12v power source. Mount the unit inside the bay but against the outer wall. Do not put the repeater in the engine compartment because of excessive heat. Do not put the repeater in the rear closet because the metal in the mirror will block the signal.

### 5th Wheel Installation

We recommend installing the repeater in or near the battery compartment under the front overhang. Mount it with hook & loop fastener or two-sided tape to the inner, exterior wall. An alternate mounting place is on the top of the pin-box. Use industrial two-sided tape and mount the repeater on the upper slope of the pin-box. Connect the positive lead to the break-away switch (which has 12v power while driving). Ground the negative lead to complete the circuit.

### Travel Trailer Installation

We recommend installing the repeater in the battery box on the front of the trailer. If the battery box is metal, connect the lines to the battery, then run the lines outside of the box and mount on the side of the battery box or the front tongue of the travel trailer.

**Note:** The red light on the repeater will illuminate “constant or blinking” (the repeater will illuminate with a constant light when power is applied, once the display is on and the sensors are reporting. The light will blink occasionally when transmitting information to the display).

If the light is not on, check your connections, source power or the in-line fuse on the positive lead of the repeater for issues.

## TROUBLESHOOTING TIPS

<b>How long should I initially charge the internal battery?</b>
<i>The display comes partially charged but you should charge the display, using the included charging components (USB-C cord and 12v adapter), for 4-5 hours. <a href="#">See page 5</a></i>
<b>Why am I am having trouble seeing the screen to program it?</b>
<i>You must remove the protective screen cover before using the display. Locate the tab in the upper right-hand corner of the screen protector and pull the protector off. <a href="#">See page 7</a></i>
<b>How does the display mount to the suction cup mount?</b>
<i>The new suction cup mount has a magnetic plate that affixes to the back of the display. Simply mount the suction cup assembly where you want it and touch the back of the display to its surface. <a href="#">See page 5</a></i>
<b>How can I change the brightness of the display?</b>
<i>The display has a photo eye that automatically regulates the display brightness. There is no manual override for it. At night, the display dims. During daylight, the display brightens.</i>
<b>How do I know what tire pressure settings to use for my high- and low-pressure alerts?</b>
<i>This display will automatically set up your alert parameters when you input the cold tire pressure you are using for your tires. It will set the high alert to 25% above that pressure and the low alert to 10% below that pressure. You can also set your high- and low-pressure alerts manually if you prefer. <a href="#">See page 11</a></i>
<b>Normally, the tire icons rotate from one to another and show me individual temperatures and pressures. How can I select one tire if I do not want to wait for the tire icons to cycle through?</b>
<i>With this new touch screen, you can just tap on a tire position to instantly view temperature and pressure for that tire. <a href="#">See page 9</a></i>
<b>Did I see this unit has a GPS component to it?</b>
<i>Yes. The GPS is not used for navigation, but it will tell you your direction of travel (compass), current time, current date, your speed, trip distance and current altitude. Allow up to 15 minutes for the GPS to initialize the first time. <b>Note: GPS feature may not be available on certain models.</b> <a href="#">See page 7</a></i>
<b>Can this display alert me to low sensor battery voltage?</b>
<i>Yes. This display will show battery voltage levels in each sensor. Tap on the “Settings” icon on the lower left on the home screen. On the next screen tap on the left or right arrows. Tap on the “Sensor Battery Voltage” icon. On the next page, tap on the tire icon to see the sensor battery voltage. <a href="#">See page 23</a></i>
<b>How long will the battery last in the display and can it be changed?</b>
<i>The battery in the display will last many years. It is designed to last the life of the display. When the internal battery is exhausted, it cannot be replaced easily. <a href="#">See page 5</a></i>
<b>What is the small antenna icon for on the display screen.</b>
<i>The antenna (Repeater Signal) icon tells you that the repeater you installed is functioning properly, (amplifying the signal from the tire sensors to the display). <a href="#">See page 5</a></i>

## TROUBLESHOOTING TIPS

<b>Is there a way to get the six-digit sensor code from the monitor?</b>
<i>Yes. On the same screen you see the sensor battery voltage, the sensor code will appear next to the voltage readout. Tap on the tire you want to see the sensor code for. <a href="#">See page 23</a></i>
<b>Is there a way to reset the display and start over with the programming?</b>
<i>Yes. Tap on the “Settings” icon on the lower left on the home screen. On the next screen tap on the left or right arrows. Tap on the “reset” icon and follow the prompts. <a href="#">See page 24</a></i>
<b>What is the battery icon in the upper left corner of the main screen indicating?</b>
<i>That battery icon is showing the amount of battery charge for the internal battery in the display only. <a href="#">See page 5</a></i>
<b>What kind of alert will I get if one or more of my tires are outside the parameters I set?</b>
<i>You will get three visual alerts and one audible alert. Text on the screen showing what the alert is, the tire icon will change from yellow to red and a red LED will flash in the lower right corner of the display unit. The unit will beep to signify an alert has occurred. <a href="#">See page 8</a></i>
<b>Is there a way to silence the alert?</b>
<i>Yes. Just tap anywhere on the screen. <a href="#">See page 8</a></i>
<b>Do I have to set up the high AND low temperature alerts?</b>
<i>There is no Low Temperature alert. Low temperature (below 158) is preferable. There is no need to monitor low temperatures.</i>
<b>How long will the screen stay on when running it on the battery?</b>
<i>First, we prefer you run the display on the internal battery and not have it plugged into a USB outlet all the time. Charge the display for several hours before you leave on a trip and run it off the battery. The battery is a lithium battery and likes to be charged and discharged for a longer overall life. Always use the provided cord and adapter to charge the display. The display will run for approximately 5-8 hours on a full charge. <a href="#">See page 5</a></i>
<b>Why can't I get the display to turn off using the slide switch on the right side of the unit?</b>
<i>For units with a 4-digit date code BEFORE 3321 (33rd week of 2021), if you have the USB charge cord plugged into the display and it is powered up, the switch will not be functional until you unplug the USB cord. <a href="#">See page 5.</a></i>
<b>What mode do I use to code a sensor into the display? Automatic or manual?</b>
<i>Typically, you need to use the “Automatic Code Learning” feature since the code for the sensor is not printed on it. Once you code it in, you can then write down the code and enter it manually at another time if needed. <a href="#">See page 15</a></i>

## TROUBLESHOOTING TIPS

**If I have a Tag Axle, how do I set up the High- and Low-pressure alerts in the display since there is no Tag Axle shown in the pressure section?**

To set up Tag Axle pressure, tap on “Pressure Alert Settings” then tap “PWR Unit” then tap “Manual Input High- and Low-Pressure Alert”. From there, put in the High-Pressure PSI (25% above cold tire pressure) and the Low-Pressure PSI (10% below cold tire pressure) in the area marked Axle 3. That will correspond to your tag axle position on the screen. [See page 13](#)

**When I turn the display on, I do not see any tire pressure or temperature readings...What’s up?**

The system takes from 3 to 8 minutes to acquire sensor readings. It is not immediate.

**I have been at a rest stop for a while and now my display is blank, why?**

The 770 Display has a motion detection feature and, if it does not detect motion for approximately 10 minutes, the screen will enter the sleep mode to conserve the internal battery. Any movement of the display will activate the screen. [See page 9](#)

**I have two different trailers I pull, both with sensors. How can I hide the tire icons for the trailer I am not pulling?**

The display has a feature called “Auto-hide”. Drive away from the trailer that is not hooked up to the towing vehicle and, in approximately 15 minutes, the trailer left behind will be made invisible on the screen automatically. [See page 9](#). You may also use the Connect/Disconnect feature. [See page 19](#)

**What does a “Fast Leak” warning mean?**

The tire showing the alert is losing 2 PSI or greater in less than 1 minute. Find a safe place to pull over and check the tire as soon as possible. [See page 9](#)

**How do I look at tire information on a tire without waiting for the display to scroll to that tire?**

On the main screen, simply tap the tire you need information on. [See page 9](#)

**Why are there dashed lines across the screen for one of my sensors?**

Dashed lines mean the sensor signal is not getting from the sensor to the monitor. It could possibly be caused by interference, a low or dead Display battery ([see page 5](#)) or a repeater not functioning ([see page 34](#)), among other things. Sensor troubleshooting or battery replacement may be needed ([see page 31-33](#)).

## SENSOR SPECIFICATIONS

Operating Temperature Range	-40°F - 176°F / -40°C - 80°C (Internal) -40°F - 230°F / -40°C - 110°C
Storage Temperature Range	-40°F - 185°F / -40°C - 85°C (Internal) -40°F - 248°F / -40°C - 120°C
Pressure Range	1-218 PSI / 1-15 BAR
Pressure Accuracy Range (w/digital gauge)	±1.5 PSI / ±0.1 BAR
Temperature Accuracy Range	±5.4°F / ±3°C
Transmission Power	<10 dBm
Transmission Frequency	433.92 MHz
Approximate Battery Life	1-1.5 years (up to 4 years for Internal)
Physical Sensor Size - Flow-Thru (CR1632)	2.2" (L) x 1" (W) x 0.9" (H) 52 (L) x 26 (W) x 23.5 (H) mm
Physical Sensor Size - Flow-Thru (CR2032)	1.7" (L) x 1" (W) x 0.94" (H) 42.6 (L) x 26.8 (W) x 24 (H) mm
Physical Sensor Size - Cap	0.96" (D) x 0.91" (H) 24.4 (D) x 23.1 (H) mm
Physical Sensor Size - Internal Screw-mounted	2.64" (L) x 1.26" (W) x 0.70" (H) 67 (L) x 32 (W) x 18 (H) mm
Physical Sensor Size - Internal Belt-mounted	2.6" (L) x 1.26" (W) x 0.79" (H) 66 (L) x 32 (W) x 20 (H) mm
Physical Sensor Size - Hybrid Cap	1.16" (D) x 1.02" (H) 29.5 (D) x 26 (H) mm
Sensor Weight - Flow-Thru (CR1632)	0.77 oz. / 22 grams
Sensor Weight - Flow-Thru (CR2032)	0.99 oz. / 28 grams
Sensor Weight - Cap	0.59 oz. / 16.8 grams
Sensor Weight - Internal Screw-mounted	1.38 oz. / 39 grams
Sensor Weight - Internal Slide-on	1.46 oz. / 41.5 grams
Sensor Weight - Hybrid Cap	0.88 oz. / 25 grams

## DISPLAY SPECIFICATIONS

Temperature Operating Range	-4°F - 176°F / -20°C - 80°C
Storage Temperature Range	-22°F - 185°F / -30°C - 85°C
Display Input Voltage	5 to 24V DC
Frequency	433.92 MHz
Size	5.28"(L) x 4.59"(W) x 0.83"(D) 134(L) x 116.5(W) x 21(D)mm
Display Weight	8.35 oz. / 236.5 grams

## PROGRAMMED SENSOR REFERENCE DIAGRAM

After pairing your sensors, you may record their 6 digit code (or sensor number) by wheel position using these Power Unit and Trailer diagrams.

This allows you to know which sensor is programmed to which tire position at a glance.

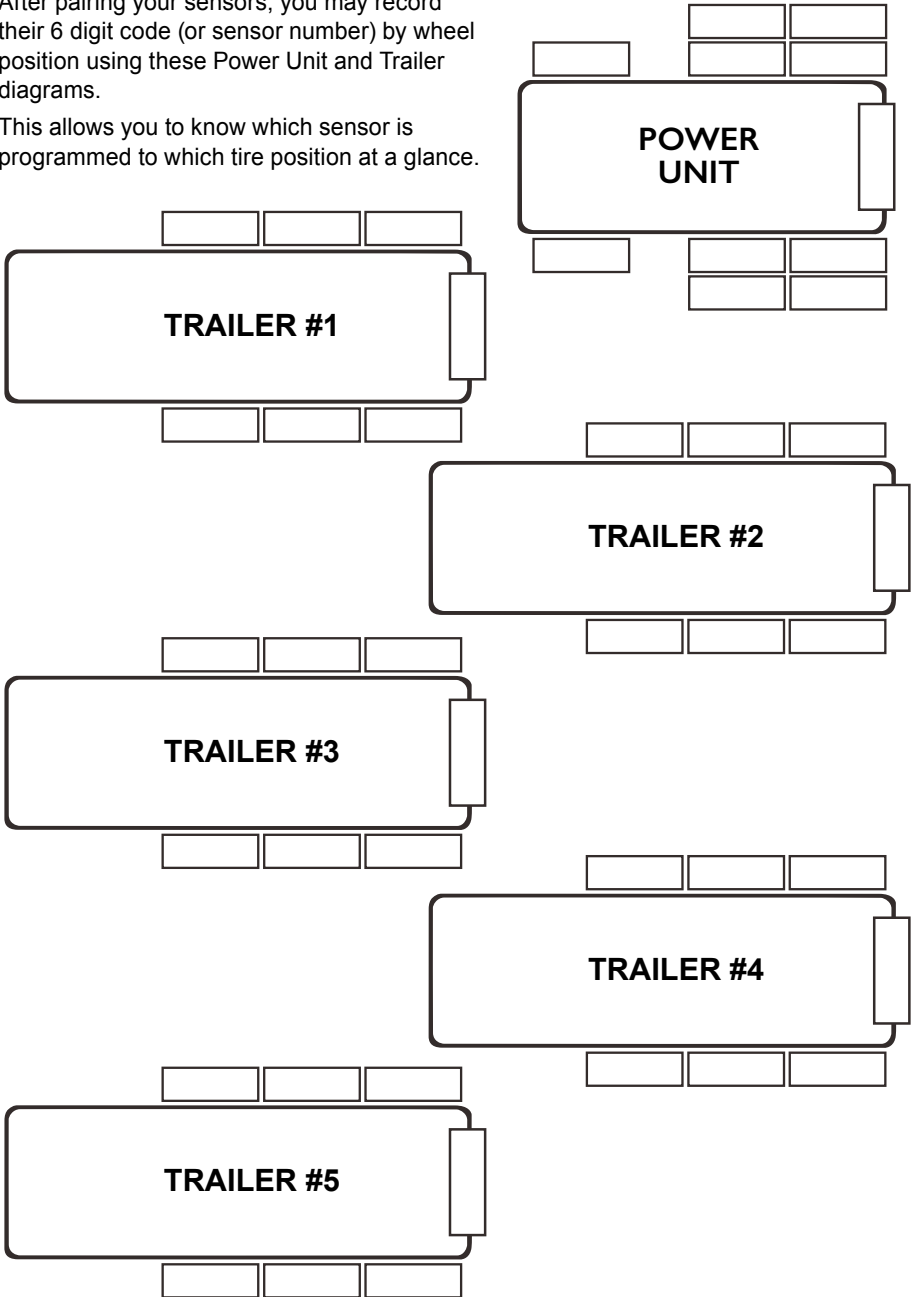



#### **DISCLAIMER**

This system is designed to monitor air pressure and temperature within the tire. It is only for added information and not meant to replace regular tire maintenance and reasonable care when operating a motor vehicle. The system cannot prevent accidents nor will TST be responsible for damage or injury due to (a) improper use, (b) failure to follow the product instructions or to perform any preventative maintenance, (c) unauthorized repair or modifications, (d) use of products beyond their useful life, or (e) external causes such as accidents, abuse, road hazards, or other actions or events beyond TST's reasonable control.

### **CUSTOMER SUPPORT INFORMATION:**

**WEB:** [www.TSTtruck.com](http://www.TSTtruck.com)

**PHONE:** (770) 889-9102

**EMAIL:** [support@TSTtruck.com](mailto:support@TSTtruck.com)

© 2024 TST by P.S.I. A **Clariance Technologies** Company.  
Implementation Standard: Q/YAT001-2017 - Made in China

TST-770 TSD Full Line Manual-RevH