

Safety Precautions

- Caution: To avoid electric shock, DO NOT splash water on the device or touch the Switch Button with wet hands.
- Caution: Turn off the power at the AC mains before wiring.
- Caution: Improper use or improper installation can cause damage/loss of property, injury, or even death.



This Relay, which supports a maximum current of 16A, is designed to make almost any conventional home appliances smart. It is HomeKit-enabled, allowing you to effortlessly manage the connected appliance over your iPhone. When in use, the Relay will also continuously measure the electrical consumption of the connected appliance, and you can check this information at any time via the Evvr App installed on your iPhone.

Thank you very much for purchasing the Evvr Energy Monitoring Smart Relay. Please read this manual carefully to learn about all the functions and uses of this Relay.

- Caution: This product is intended for indoor use only.
- Caution: Metal casings, mirrors, electrical appliances, etc., may affect, reduce, or interfere with wireless communication.



What's in the Box

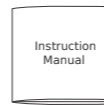
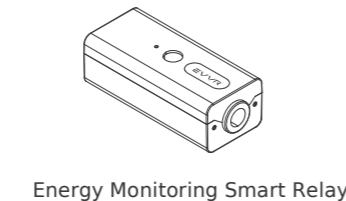

Instruction Manual

Technical Specifications

Model	CHW01
Input	AC 85V~245V 50/60Hz
Max. Load	16A
Wireless Standard	IEEE 802.11 b/g/n Wi-Fi 2.4GHz
Power Consumption	0.65W
Operating Temperature	-20~60°C (-4°~140°F)
Storage Temperature	-40~85°C (-40°~185°F)
Ambient Humidity	5~85% RH
Product Size (L*W*H)	100mm*42.8mm*32mm (3.94in. x 1.69in. x 1.26in.)

Part Names

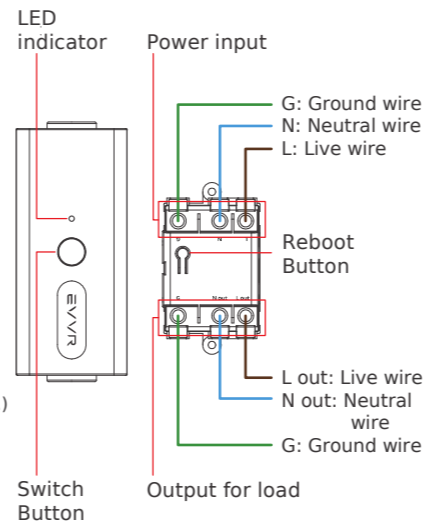

Wiring

For your safety, we recommend that you ask a professional electrician for help installing this Relay.

For appliances that have three wires (live, neutral & ground wires):

1. Turn off the power at the AC mains.
2. Cut the power cable connecting the appliance into two segments. Strip each segment to expose 10mm of each of the three wires. Then, identify the live wire, neutral wire, and the ground wire.

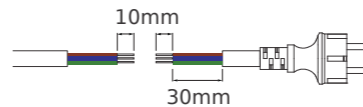

3. Remove the exterior case of the Relay with the T4 screwdriver.

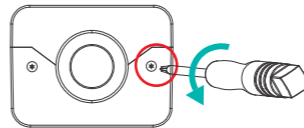

4. Connect the Relay between the appliance and the AC mains as follows:

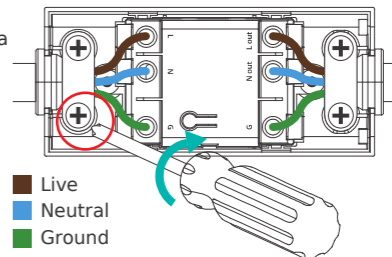

On the Appliance side of the Relay

- L OUT - the live wire
- N OUT - the neutral wire
- G - the ground wire

On the AC mains side of the Relay

- L - the live wire
- N - the neutral wire
- G - the ground wire

5. Fasten the wires with screws, and then put the exterior case back in place.
6. Turn on the power at the AC mains.

For appliances that have two wires (live & neutral wires, no ground wire), please follow the action performed in 10 minutes. If you want to set up the Relay again, please reboot it into setup mode once again.

Setup Instructions

This Relay uses Wi-Fi 2.4GHz networking. It is HomeKit-enabled and you can set it up on your iPhone.

When powered on for the first time, the Relay will automatically go into the setup mode (indicated by a continuous blue blinking light).

In this mode, you can add the Relay to the Home App.

1. Open the Home App on your iPhone, tap "+", and then tap Add Accessory.
2. Scan the QR code or input the 8-digit setup code.

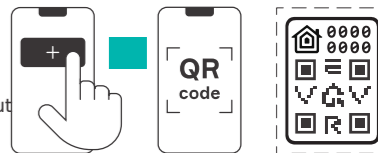

Note: The setup mode will exit if there is no action performed in 10 minutes. If you want to set up the Relay again, please reboot it into setup mode once again.

Indicator Light Status

- Blue blinking (continuous): The Relay is in the setup mode.
- Blue blinking (3 blinks): The Switch Button is disabled.
- Blue steady: The Relay is on; HomeKit & Wi-Fi are connected.
- Red blinking (continuous): Wi-Fi is disconnected.
- Red blinking (2 blinks): The Relay is restored to factory settings.
- Red blinking (3 blinks): The Relay is overloaded or exceeds the temperature limit.
- Red steady: The Relay is on; HomeKit & Wi-Fi are disconnected.

Expanded Functionality with the Evvr App

When the Relay is in use, you can use the Evvr App to further expand the Relay's functionality. You can check electricity consumption, disable the Switch Button in case of unintended touch, and configure the status of the Relay when it is re-powered on after a loss of power.

1. Install the Evvr App on your iPhone from the Apple App Store.
2. Allow the App to gain access to HomeKit's devices.

Restore to Factory Settings

There are two methods to restore the Relay to factory settings:

1. Using Switch Button on the exterior of the plastic case
 - i. Disconnect the Relay from power.
 - ii. While pressing and holding the Button, reconnect the Relay to power.
 - iii. Keep holding the Button for another 10 seconds until the red LED blinks twice.
2. Using Reboot Button on the interior of the plastic case

Press and hold Button 2 for 5 seconds until the red LED blinks twice.

Troubleshooting

Q1. Smart Relay pairing failed.

1. The device may be too far from the Wi-Fi router, or there may be interference in the current network environment. Please try to bring devices closer to the Wi-Fi router.

2. The device may be already paired. Please return the device to factory defaults if you want to pair it again.

Q2. Smart Relay cannot be controlled by Apple Home APP.

The device may be installed too far from the Wi-Fi router, or there may be signal interference. Please check whether there is strong electromagnetic field equipment near the wireless switch and check whether the equipment is installed in a closed metal housing or in a closed concrete wall.

Legal Notice

Use of the Works with Apple badge means that an accessory has been designed to work specifically with the technology identified in the badge and has been certified by the developer to meet Apple performance standards. Apple is not responsible for the operation of this device or its compliance with safety and regulatory standards.

Apple, HomeKit, HomePod, HomePod mini, iPad, iPhone and Apple TV are trademarks of Apple Inc., registered in the U.S. and other countries and regions.

Certifications (regional)

FCC ID: 2A68U-CHW01



FCC Statement

This device complies with part 15 of the FCC rules. Operation is subject to the following two conditions:

(1) this device may not cause harmful interference and (2) this device must accept any interference received, including interference that may cause undesired operation.

Changes or modifications not expressly approved by the party responsible for compliance could void the user's authority to operate the equipment.

Note: This equipment has been tested and found to comply with the limits for a Class B digital device, pursuant to part 15 of the FCC Rules. These limits are designed to provide reasonable protection against harmful interference in a residential installation.

This equipment generates, uses and can radiate radio frequency energy and, if not installed and used in accordance with the instructions, may cause harmful interference to radio communications.

However, there is no guarantee that interference will not occur in a particular installation. If this equipment does cause harmful interference to radio or television reception, which can be determined by turning the equipment off and on, the user is encouraged to try to correct the interference by one or more of the following measures:

- Reorient or relocate the receiving antenna.
- Consult the dealer or an experienced technician for help.

Important Announcement Important Note Radiation Exposure Statement

This equipment complies with FCC radiation exposure limits set forth for an uncontrolled environment. This equipment should be installed and operated with minimum distance 20cm between the radiator and your body.

This transmitter must not be co-located or operating in conjunction with any other antenna or transmitter.

Disposal Instructions

This product must not be disposed of with your other household waste. Instead, it is your responsibility to dispose of your waste equipment by handing it over to a designated collection point for the recycling of waste electrical and electronic equipment. The separate collection and recycling of your waste equipment at the time of disposal will help to conserve natural resources and ensure that it is recycled in a manner that protects human health and the environment. For more information about where you can drop off your waste equipment for recycling, please contact your local city office, your household waste disposal service or the shop where you purchased the product.

Warranty Policy

For warranty information, please visit <https://www.evvr.io/warranty>



Please contact us for any technical issue
support@evvr.io

Rev. A-022823

P/N CHW01