



# In-Wall Relay Switch

## Smart Relay Instruction Manual

Rev. A-123022

P/N SRHW01

*\*Please see separate Evvr Smart Switch Sub-Assembly manual for complete instructions.*

### Complete Accessories Include

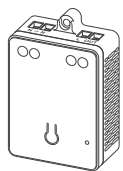

Smart Relay x1



Double Sided Foam Pad x1



Fixing Screw x1

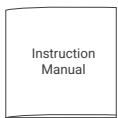

Instruction Manual x1

### Product Introduction

**Smart Relay** uses Wi-Fi technology and may be used in different loads, including incandescent lamps, halogen lamps, LED lamps and fluorescent lamps. It is small enough to be installed in light switch boxes and body of most light fixtures. This device uses Apple HomeKit technology for remote control and inter-operation.

### Technical Specifications

Model	SRHW01
Input Voltage	AC 85V~245V
Max. Load Power	AC 110V/300W AC 220V/600W
Min. Load Power	No limit
Applicable to	Light Fixtures
Operating Temperature	0~40°C (32°~104°F)
Operating Humidity	5~85% RH
Wireless Connectivity	Wi-Fi 2.4GHz IEEE 802.11
Wireless Profile	HomeKit
RF Characteristics	Operating frequency: 2.4GHz Range: 50m~80m Internal antenna
Product Size (L*W*H)	2.34in. x 1.55in. x 0.83in. (59.4mm * 39.3mm * 21.2mm)

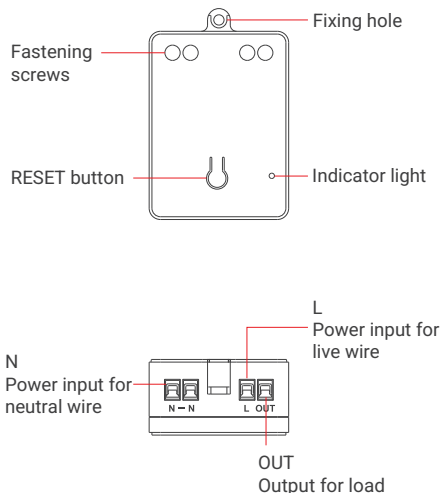

### Installation Instructions

**Caution:** Read this manual before attempting to install the device! Using this product in a manner other than intended voids your warranty. Further, Evvr ApS is NOT liable for any damage incurred with the misuse of this product.

**Caution:** All installations of this device should be performed by a qualified or licensed electrician!

**Caution:** Product must be installed on a 10A line.

**Caution:** Metal casings, mirrors, electrical appliances, etc., may affect, reduce, or interfere with wireless communication.



**Warning:** Turn OFF electrical power from the breaker box or electrical service panel before installing or servicing this product. Improper use or installation can cause SERIOUS INJURY, DEATH, or LOSS/DAMAGE OF PROPERTY.



**Caution:** Use this product in an indoor environment.

## 1 Connect wires per wiring diagram as follows

**Caution:** If you have purchased a **Smart Switch Sub-Assembly** to use with it, please follow the installation instructions on the **Smart Switch Sub-Assembly** manual.

With **Smart Relay**, you can turn a traditional lamp into a HomeKit smart lamp. It is recommended to install **Smart Relay** near the lamp.

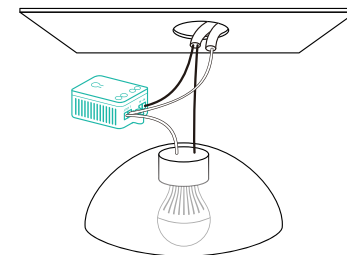

You can choose one of the two diagrams below to connect the wires according to your installation environment.

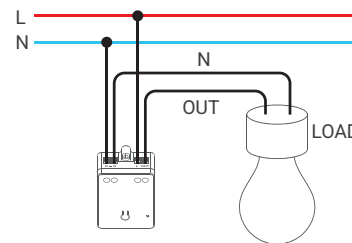

### NOTES FOR THE DIAGRAM:

N - neutral wire

L - live wire

OUT - output live wire

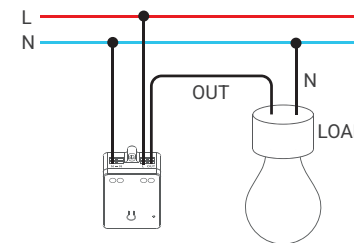

## 2 Fix Smart Relay on a flat, cleaned surface



Stick the foam pad to the recommended position on the **Smart Relay** and then place the relay on a flat, cleaned surface.

**Turn ON electrical power** and check if the wires are connected correctly. If wires are properly connected, the indicator light will come on while light(s) connected to the switch is turned on.

## Operating Instructions

**Important:** The **In-Wall Relay Switch** can be controlled from a iOS device.

**Note:** The indicator will blink blue when the device is in setup mode.

To control this HomeKit-enabled accessory, the latest version of iOS or iPadOS is recommended.

A customer who owns an Apple TV (4th generation or later) with tvOS 10 or later, an iPad with iOS 10 or later, or a HomePod or HomePod mini can control HomeKit-enabled accessories away from home and automatically through triggers such as time of day, location, sensor detection, or the action of an accessory.

### Add Smart Relay to Apple HomeKit

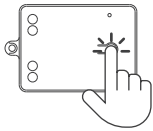

Set the **Smart Relay** into setup mode by short press the **RESET** button. (When the device is not added to the HomeKit network, it enters setup mode for 10 minutes each time it reboots)



Open the Apple Home app and select "Add Accessory"



Locate and scan the HomeKit setup code on the device or on the front page of this manual, then follow the instructions in the Apple Home app.

### Unpairing Smart Relay from Wi-Fi Router

Press and hold the **RESET** button for more than **2** seconds (the indicator light will flash once)



### Restore Smart Relay to factory Settings

Press and hold the **RESET** button for more than **5** seconds (the indicator light will double-flash once)

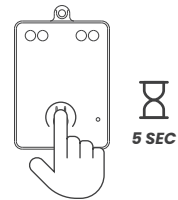

### Indicator Light Status



Color	Activity	Wi-Fi Connection	HomeKit Connection
Blue	Glowing	✓	✓
Red	Glowing	✗	✗
Red	Flashing	✗	✓
Red	Double flashing	✓	✗

### Type of Connected Switch

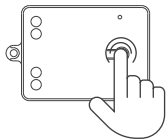

Double-click the reset button to switch between the three switching modes.

Switch	Indicator
toggle switch (device changes status when switch changes status)	the indicator will blink purple once
toggle switch (contact closed - ON, contact opened - OFF)	the indicator will blink purple twice
momentary switch	the indicator will blink purple three times

## Troubleshooting

### Q1 Smart Relay pairing failed.

- The device may be too far from the Wi-Fi router, or there may be interference in the current network environment. Please try to bring devices closer to the Wi-Fi router.
- The device may be already paired. Please return the device to factory defaults if you want to pair again.

### Q2 Smart Relay cannot be controlled by Apple Home APP.

The device may be installed too far from the Wi-Fi router, or there may be signal interference. Please check whether there is strong electromagnetic field equipment near the wireless switch and check whether the equipment is installed in a closed metal housing or in a closed concrete wall. Add Wi-Fi router or bring devices closer to the Wi-Fi router.

### Q3 The light turns off automatically after a short period of time (approximately 150 seconds).

The power of the light may exceed the maximum power (AC 110V/ 300W, AC 220V/600W). Please check whether the power of the light exceeds the maximum power.

### Q4 In case of power loss while the lights were on, the light status is on when power is restored?

Yes. The device will record the status of the light, and after the device is powered off, re-powering will restore the state before the device was powered off.

## Legal Notice

Use of the Works with Apple badge means that an accessory has been designed to work specifically with the technology identified in the badge and has been certified by the developer to meet Apple performance standards. Apple is not responsible for the operation of this device or its compliance with safety and regulatory standards.

Apple, HomeKit, HomePod, HomePod mini, iPad, iPhone and Apple TV are trademarks of Apple Inc., registered in the U.S. and other countries and regions.

## Certifications (regional)

FCC ID: 2A68U-SRHW01



### FCC Statement

This device complies with part 15 of the FCC rules. Operation is subject to the following two conditions:

(1) this device may not cause harmful interference, and (2) this device must accept any interference received, including interference that may cause undesired operation.

Changes or modifications not expressly approved by the party responsible for compliance could void the user's authority to operate the equipment.

**Note:** This equipment has been tested and found to comply with the limits for a Class B digital device, pursuant to part 15 of the FCC Rules. These limits are designed to provide reasonable protection against harmful interference in a residential installation.

This equipment generates, uses and can radiate radio frequency energy and, if not installed and used in accordance with the instructions, may cause harmful interference to radio communications. However, there is no guarantee that interference will not occur in a particular installation. If this equipment does cause harmful interference to radio or television reception, which can be determined by turning the equipment off and on, the user is encouraged to try to correct the interference by one or more of the following measures:

- Reorient or relocate the receiving antenna.
- Consult the dealer or an experienced technician for help.

### Important Announcement Important Note Radiation Exposure Statement

This equipment complies with FCC radiation exposure limits set forth for an uncontrolled environment. This equipment should be installed and operated with minimum distance 20cm between the radiator and your body.

This transmitter must not be co-located or operating in conjunction with any other antenna or transmitter.

## Disposal Instructions

This product must not be disposed of with your other household waste. Instead, it is your responsibility to dispose of your waste equipment by handing it over to a designated collection point for the recycling of waste electrical and electronic equipment. The separate collection and recycling of your waste equipment at the time of disposal will help to conserve natural resources and ensure that it is recycled in a manner that protects human health and the environment. For more information about where you can drop off your waste equipment for recycling, please contact your local city office, your household waste disposal service or the shop where you purchased the product.

## Warranty Policy

For warranty information, please visit <https://www.evr.io/warranty>

# EVVR

Please contact us for any technical issue  
[support@evr.io](mailto:support@evr.io)