













**ANTENNAS | OMNI-296 SERIES**

## OMNI-DIRECTIONAL, DUAL-BAND WI-FI ANTENNA

2400 - 2500 MHz, 3400 - 3800 MHz & 5000 - 6000 MHz, 7.5 dBi



 2400 – 2500 MHz; 3400 – 3800 MHz; 5000 – 6000 MHz	 7.5 dBi	 Increase x Mb/s	 Omni- Directional	 2.4 - 2.5 GHz 5.0 - 6.0 GHz	 CBRS Band	 5G Ready
 IoT	 Machine to Machine	 IP 65	 -40°C to +70°C	 Fire Resistant	 Urban Rural/Farm	

- **Dual-band 2.4 GHz and 5 GHz Wi-Fi antenna**
- **Omni-directional antenna with medium gain**
- **Compliant with IEEE 802.11b/g/n and 802.11ac wireless standard**
- **Covers the 3.5 GHz CBRS band for future 5G applications**
- **Vandal and water-resistant enclosure (IP 65)**

APPLICATION AREAS

### Product Overview

The OMNI-296 antenna is a dual-band Wi-Fi omni-directional antenna, developed by Poynting Antennas. The antenna can connect to any Wi-Fi access point whether it is older Wi-Fi technology or new dual band Wi-Fi technology. The antenna can therefore be used to resolve channel saturation and provide the ultimate in Wi-Fi performance and flexibility. This means that the antenna can also be used for point to point links where there is abundance of RF noise and cluttered environments.

The antenna operates in the two Wi-Fi frequency bands (2.4 GHz and 5 GHz), offering excellent utilization of the radio spectrum. The antenna has a maximum gain of 6dBi in the 2.4GHz band and 7.5dBi in the 5GHz band, which offers the best performance with reliable connections. The antenna also covers the 3.5 GHz CBRS band, which will be used for future 5G technologies with a peak gain of 7dBi. The housing is made of ABS which is a high impact resistant plastic and is also resistant to acids and other chemicals that may occur in industrial plants. The antenna has an N-Type female connector at its base which can be connected to a cable of the desired type and length.

### Features

- Dual-band Wi-Fi antenna for 2.4 GHz and 5 GHz
- Medium gain omni-directional antenna
- Covers 3.5 GHz CBRS band for future 5G applications
- Robust and weather resistant
- Lightweight design

### Application Areas

- Small business
- Building sites and open cast mines
- Production facilities and factories
- M2M and IoT applications
- Areas with large amounts of machinery (cluttered environments)



### Frequency Bands

The OMNI-296 is an omni-directional antenna that works from 2400 – 2500 MHz | 3400 – 3800 MHz | 5000 – 6000 MHz

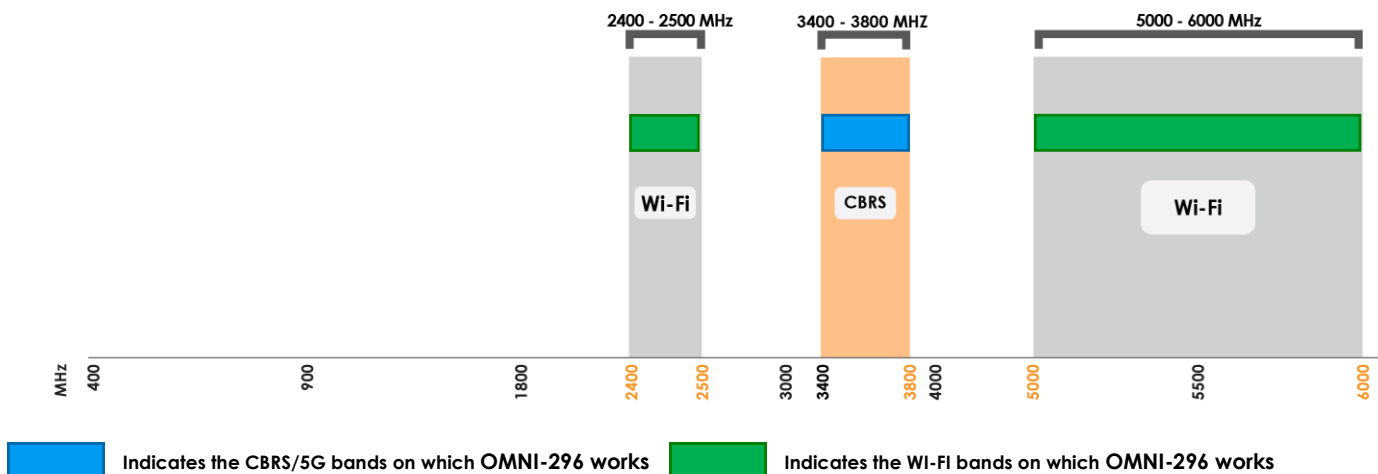

### Antenna Overview

Ports	1
SISO / MIMO	SISO
Frequency Bands	2400 – 2500 MHz, 3400 – 3800 MHz 5000 – 6000 MHz
Polarisation	Linear Vertical
Peak Gain	7.5 dBi
Coax Cable Type	N/A
Coax Cable Length	N/A
Connector Type	N-Type (F)

## Electrical Specifications

<b>Frequency bands:</b>	2400 – 2500 MHz 3400 – 3800 MHz 5000 – 6000 MHz
<b>Gain (max):</b>	6 dBi @ 2400-2500 MHz 7 dBi @ 3400-3800 MHz 7.5 dBi @ 5000-6000 MHz
<b>VSWR:</b>	<2.5:1
<b>Feed power handling:</b>	10 W
<b>Input impedance:</b>	50 Ohm (nominal)
<b>Polarisation:</b>	Linear Vertical
<b>DC short:</b>	Yes

## Product Box Contents

<b>Antenna:</b>	A-OMNI-0296-V1
<b>Mounting bracket:</b>	Pole up to 50mm diameter wall and Pole mount stainless steel bracket

## Ordering Information

<b>Commercial name:</b>	OMNI-296-V1
<b>Order product code:</b>	A-OMNI-0296-V1
<b>EAN number:</b>	0707273469694

## Mechanical Specifications

<b>Product dimensions</b>	485 mm x Ø71 mm (excl. bracket)
<b>Packaged dimensions:</b>	510 mm x 95 mm x 95 mm
<b>Weight:</b>	0.75 kg
<b>Packaged weight:</b>	0.91 kg
<b>Radome material:</b>	ABS (Halogen Free)
<b>Radome colour:</b>	Pantone - Cool Gray (1c)
<b>Mounting Type:</b>	Pole and Wall

## Environmental Specifications, Certification & Approvals

<b>Wind Survival:</b>	≤190 km/h
<b>Temperature Range (Operating):</b>	-40°C to +70°C
<b>Environmental Conditions:</b>	Outdoor/Indoor
<b>Water ingress protection ratio/standard:</b>	IP 65
<b>Salt Spray:</b>	MIL-STD 810F/ASTM B117
<b>Operating Relative Humidity:</b>	Up to 98%
<b>Storage Humidity:</b>	5% to 95% - non-condensing
<b>Storage Temperature:</b>	-40°C to +70°C
<b>Enclosure Flammability Rating:</b>	UL 94-HB
<b>Impact resistance:</b>	IK 08
<b>Product Safety &amp; Environmental:</b>	Complies with CE and RoHS standards



Antenna Performance Plots

VSWR

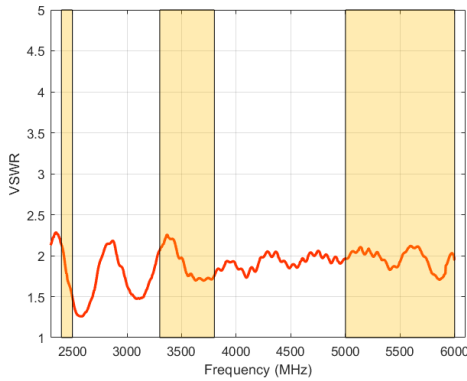

GAIN (EXCLUDING CABLE LOSS)

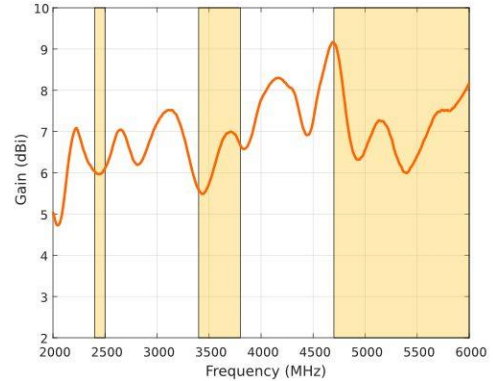

Voltage Standing Wave Ratio (VSWR)

VSWR is a measure of how efficiently radio-frequency power is transmitted from a power source, through a transmission line, into a load. In an ideal system, 100% of the energy is transmitted which corresponds to a VSWR of 1:1.

The OMNI-296 delivers superior performance across all bands with a VSWR of 2.5:1 or better.

Gain\* in dBi

7.5 dBi is the peak gain across all bands from 2400 – 6000 MHz

Gain @ 2400 – 2500 MHz:	6 dBi
Gain @ 3400 – 3800 MHz:	7 dBi
Gain @ 5000 – 6000 MHz:	7.5 dBi

*\*Antenna gain measured with polarisation aligned standard antenna*

Technical Drawings

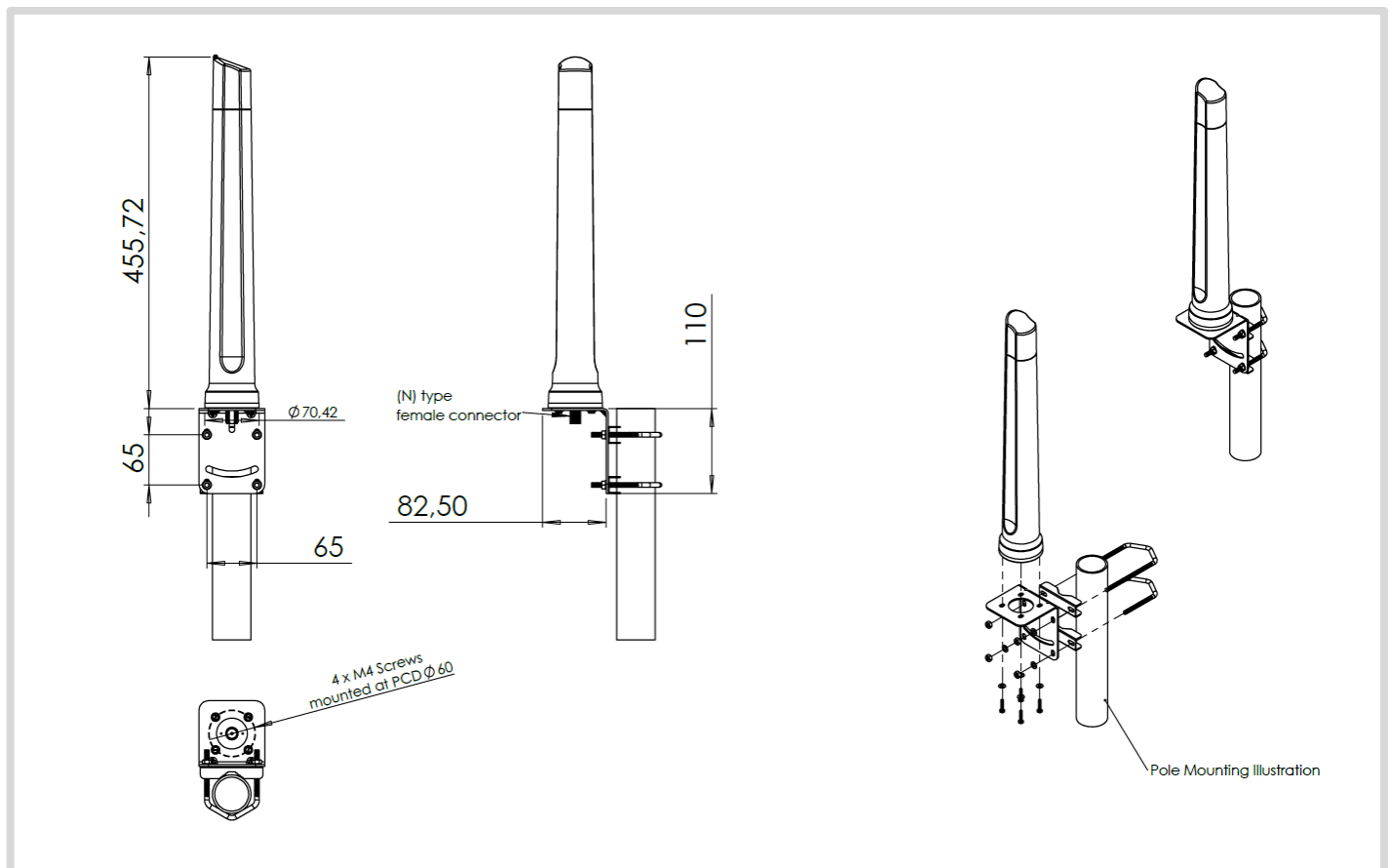

**Radiation Patterns**

Azimuth: 2400 – 2500 MHz

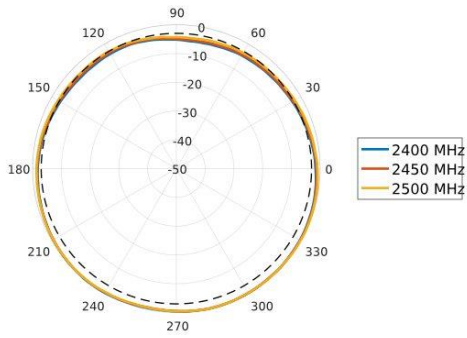

Azimuth: 3400 – 3800 MHz

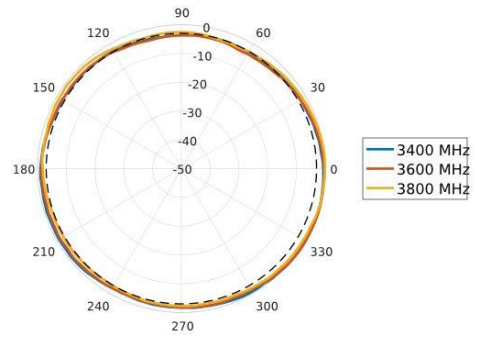

Azimuth: 5000 – 6000 MHz

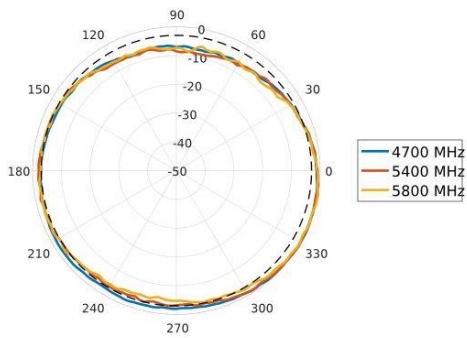

Elevation: 2400 – 2500 MHz

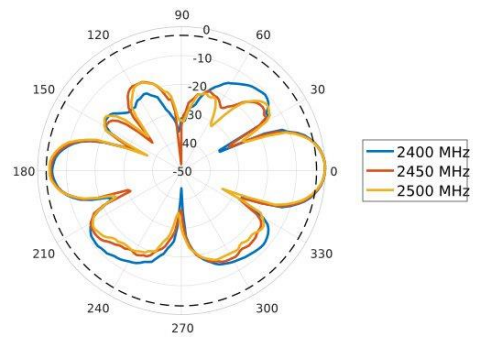

Elevation: 3400 – 3800 MHz

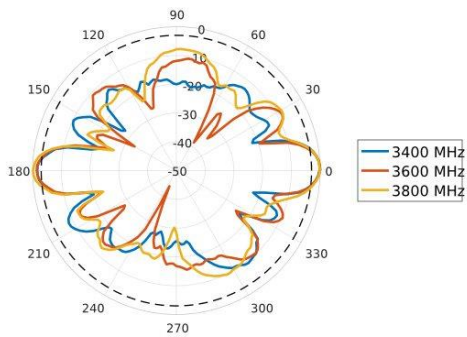

Elevation: 5000 – 6000 MHz

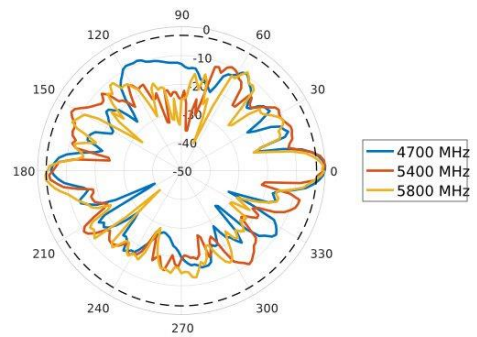

**Mounting Options**

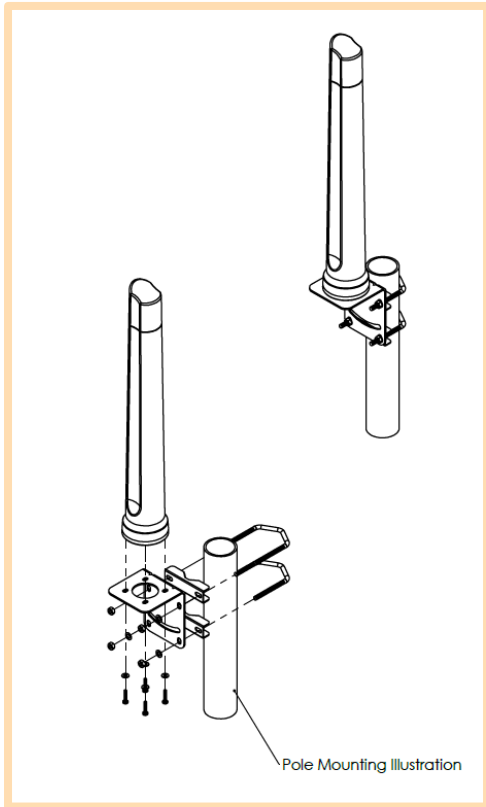

**Pole Mount**

Pole/Wall Mounting bracket (included)

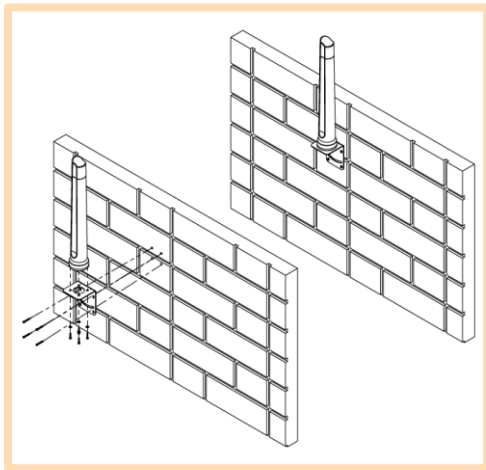

**Wall Mount**

Pole/Wall Mounting bracket (included)

---

### Additional Accessories

Extension Cables: Up to 15m HDF 195  
Various connectors available  
Installation poles and brackets available

See accessories technical specifications on [www.poynting.tech](http://www.poynting.tech)



**MobileMustHave**  
MOBILE LIFESTYLE SOLUTIONS

---

### Contact Poynting

#### Poynting Antennas (Pty) Ltd - Head Office

Unit 4, N1 Industrial Park  
Landmarks Avenue,  
Samrand, 0157  
South Africa

**Phone:** +27 (0) 12 657 0050

**E-mail:** sales@poynting.co.za

#### Poynting Europe

Regus Business Center Neue Messe Riem  
Kronstadter Straße 4  
81677 München  
Germany

**Phone:** +49 89 208026538

**E-mail:** sales-europe@poynting.tech